

**ENVITEC<sup>®</sup>**



**fluidmac**  
pump solution

**AODD PUMPS**

[www.envitec.no](http://www.envitec.no)

ENGLISH 



## MAIN FEATURES

Fluimac is an original, young and dynamic company built in 2012 for a new concept of product. It is specialized in providing pump solutions with an innovative and continuously developing design of range. The huge experience, knowledge and efficiency of its team is the starting point of its own business.

Fluimac stands out for its reliable and prompt technical support and assistance. The internal research and development department ensures the proficiency of its team, which constantly grows in order to satisfy all the customers' needs. The company keeps up with the constant evolution of the national and international market and its quality control guarantees innovative and certificated products, which respect current legal standards.

The organization of the warehouse and the assembly/testing department, allows the company to offer short delivery times, immediate check of availability, speedy shipments and fast service assistance. The policy of Fluimac relies also on excellent customer service and a network of efficient, reliable distributors who ensure willingness, quality and technical support. This makes Fluimac a high quality company, grounded in excellence.





## **OUR VISION**

To be your partner of choice for pumping solutions, globally.

## **OUR MISSION**

Fluimac, is a passionate, dedicated Global Family of Professionals. We listen to each of our Partners and are committed to deliver the right solution in the Fluid handling and Industrial Process market.

## **OUR VALUES**

Mutual Respect Doing business is about being able to generate trust between Customer and Supplier, and this trust can only be developed if there is a basis of mutual respect. So, at Fluimac we believe in extending the Mutual Respect we have as an internal ethic and bringing it to our Business Partnerships. We'll make sure we deliver against our commitments, on time and in a transparent fashion, so you know can plan for your own business needs.



**PAG 5**

## AIR OPERATED DOUBLE DIAPHRAGM PUMPS

Flow-rate from 4 lt/min to 1.050 lt/min.  
Special version Available.

**PAG II**

## PHOENIX

Air operated double diaphragm pumps  
Flow-rate from 4 lt/min to 1.050 lt/min.



**PAG 25**

## PHOENIX FOOD

Air operated double diaphragms pumps  
Flow-rate from 20 lt/min to 1.050 lt/min.



**PAG 30**

## SPECIAL PUMPS

Phoenix Atex, Accurate Phoenix, Flap Phoenix, Steel Phoenix, Drum Phoenix, Twin Phoenix, Submersible Phoenix and Power Phoenix.



**PAG 35**

## DAMPER

Pneumatic, automatic pulsation dampeners.  
Applicable to all size of pumps. Available also in ATEX and FOOD version.

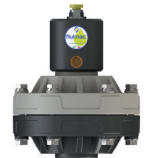

**PAG 39**

## LOTUS

Pure Air operated double diaphragm pumps  
Flow-rate from 55 lt/min to 110 lt/min



**PAG 46**

## PIEZO

Air operated sampling pumps  
Flow-rate 8 lt/min



**PAG 51**

## ACCESORIES

Accessories Air operated double diaphragm pumps





# AIR OPERATED DOUBLE DIAPHRAGM PUMPS

**MATERIALS OF CONSTRUCTION:**  
PP, PVDF+CF, ALUMINIUM, SS AISI 316, POMc  
Flow-rate from 4 lt/min to 1.050 lt/min

# PUMP OPERATION

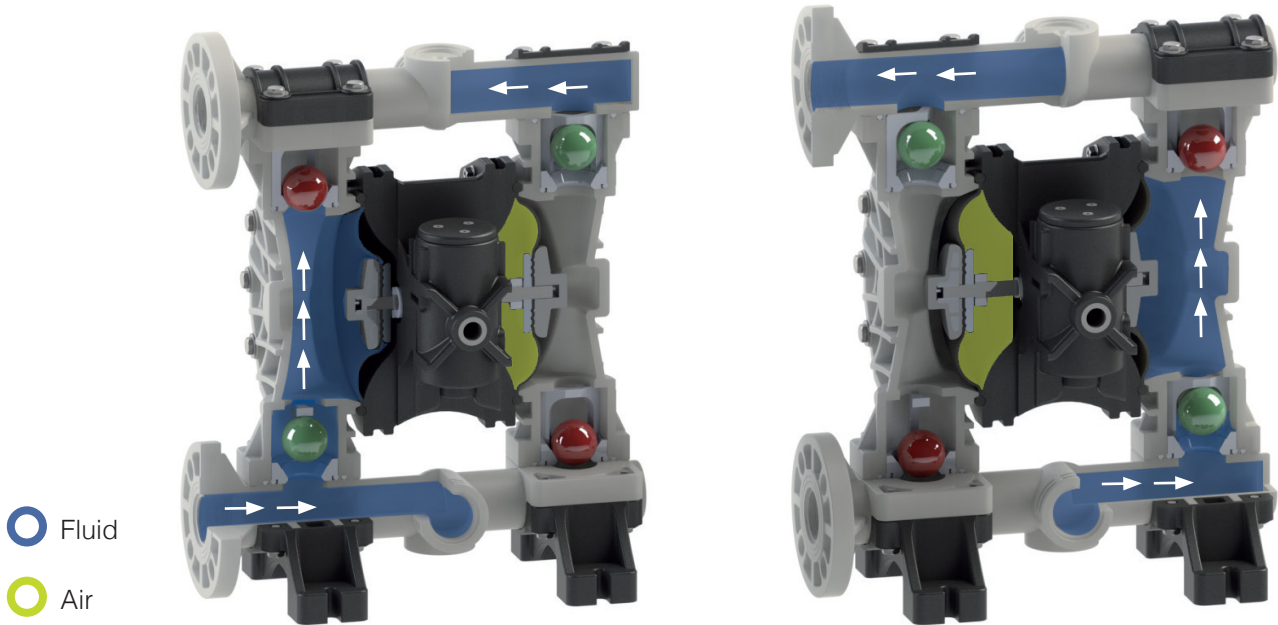

○ Fluid  
○ Air

1

## Suction Cycle

Compressed air fills right inner chamber, causing the opposing diaphragm to create suction, lifting the lower valve ball, pulling in fluid at inlet. Simultaneously, the right chamber is in "Discharge" cycle.

2

## Discharge Cycle

Compressed air fills left inner chamber, causing upper valve ball to open and discharge fluid. Simultaneously, the right chamber is in "Suction" cycle.

## INSTALLATION



**Pump installed below head (positive suction)**  
when it is necessary to empty completely the container



**Self priming pump installed above head (negative suction)**  
pump initially works with dry column without problem



**Pump installed above drum or tank**  
with special featuring pump

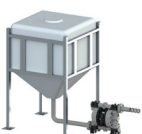

**Pump installed on hopper for high viscosity liquid**  
hopper's height helps the pump to treat the fluid. Air pressure has to be high, Suction tube has to be bigger than pump's size

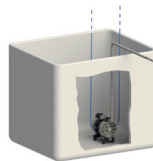

**Submerged pump**  
it is necessary to check the chemical compatibility



**Suspended**  
special version with fixing feet also in the upper part, for ceiling fixing



**Pump installed on a mobile unit**  
with a trolley or cart when pump must be often moved

# TECHNICAL FEATURES

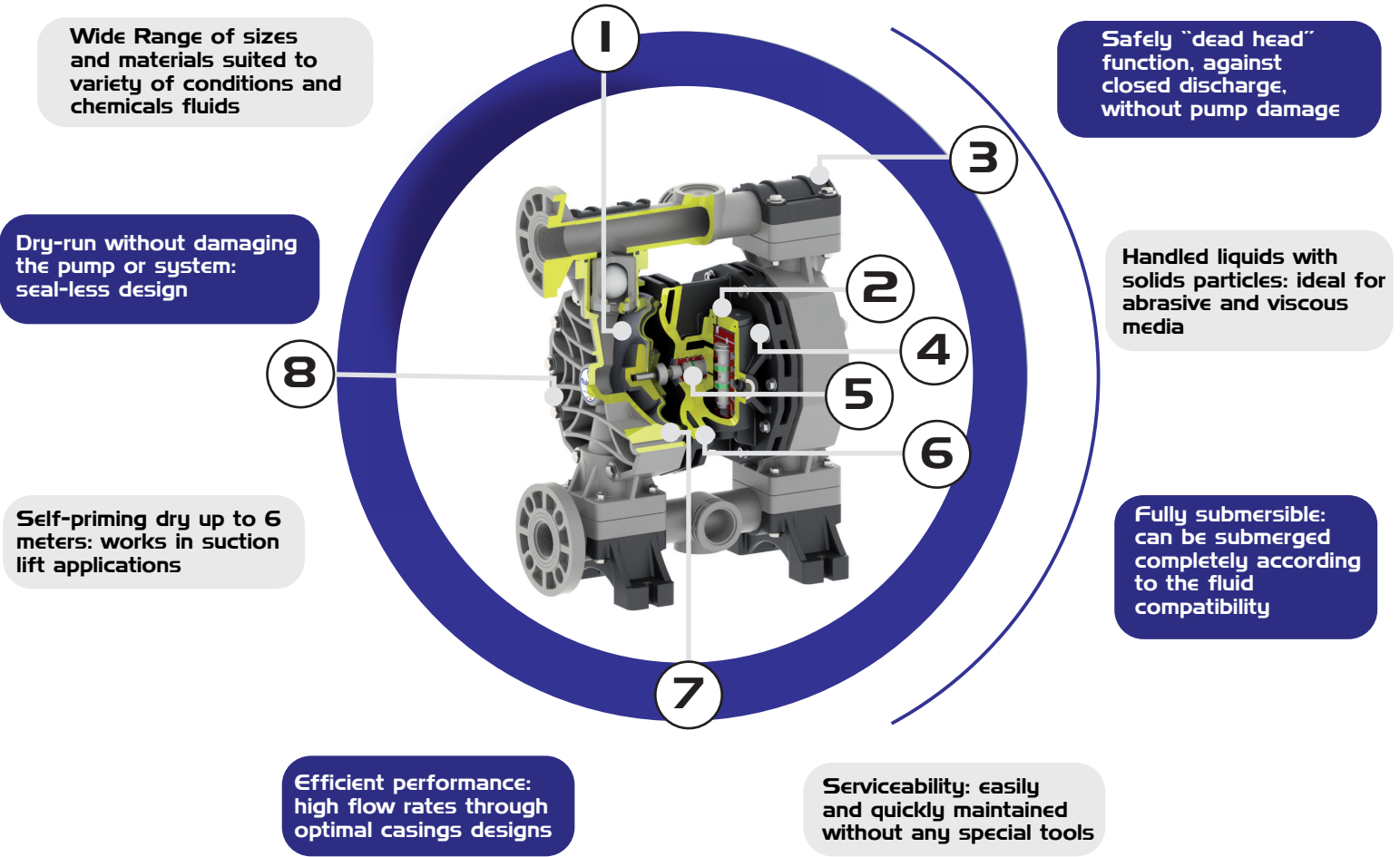

1	2	3	4	5	6	7	8
Long-lasting diaphragm construction ensures a consistent performance and a longer operating life.	Efficient air distribution design: low air consumption. Un-balanced pilot spool, precisely controls positioning of the main power spool to eliminate stalling and increase efficiency.	All bolted design for an effective sealing to extended leak-proof service.	Solid polypropylene air chambers and plastic air valve for maximum chemical resistance in highly corrosive environments.	Acetalic shuttle ensures long valve life, auto-lubricated material.	Pneumatic exchanger is easily externally accessible for a quick inspection. Special Air system: lube-free, non-stall, non-freeze.	Special pinch clamping, design to minimize wear and increase life of the diaphragm, and provides a uniform seal to avoid leak.	Special exhaust chamber with double silencer to expand diffusion passages, reduce the icing and assure low noise level.

**QUALITY** 100% wet tested after final assembly: deadheading, priming and sealing

**SAFE** ATEX certifications in all versions: Conductive plastic pumps available

**FLEXIBILITY** Multiple porting options available along with interface options

# P 0120

# P-

# HT

# T

## MODEL

## SIZE

## CASING

## DIAPHRAGM

## BALL

### P PHOENIX



**4**  
4 lt/min  
1/4" BSPP

### PF PHOENIX FOOD



**8**  
7 lt/min  
1/4" BSPP

### AP ACCURATE PHOENIX



**20**  
20 lt/min  
3/8" BSPP

### TP TWIN PHOENIX



**35**  
35 lt/min  
1/2" BSPP

### PP POWDER PHOENIX



**55**  
55 lt/min  
1/2" BSPP

### PS SUBMERSIBLE PHOENIX

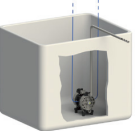

**60**  
65 lt/min  
1/2" BSPP

### DP DRUM PHOENIX



**90**  
100 lt/min  
3/4" BSPP

### FP FLAP PHOENIX



**120**  
120 lt/min  
1" BSPP

**170**  
170 lt/min  
1" BSPP/DN25

**252**  
250 lt/min  
1" 1/4 BSPP

**400**  
380 lt/min  
1" 1/2 BSPP DN40

**700**  
700 lt/min  
2" BSPP DN50

**1000**  
1050 lt/min  
3" BSPP DN80



**P  
POLYPROPYLENE**  
Wide chemical compatibility. General purpose. Reinforced with glass-fiber.



**PC  
CONDUCTIVE  
POLYPROPYLENE**  
Wide chemical compatibility. General purpose. Groundable.



**KC  
CONDUCTIVE PVDF**  
Strong chemical resistance to acids. High temperature resistance. Groundable.



**O  
ACETAL**  
Wide range of solvent and hydrocarbons resistance. Good level of abrasion resistance. (Just 4, 8 and 10 size).



**OC  
CONDUCTIVE  
ACETAL**  
Wide range of solvent and hydrocarbons. Good level of abrasion resistance. Groundable. (Just 4, 8 and 10 size).



**A  
ALUMINUM**  
Wide range of solvent and hydrocarbons. Good level of abrasion resistance.



**S  
SS – AISI 316  
Electropolished**  
High level of corrosion and abrasion resistance.



**H  
HYTREL**  
Good low temperature properties. Good abrasion resistance.



**W  
SANTOPRENE HIGH  
RESISTANCE**  
Solutions and dilute acids.



**NBR  
NBR**  
Good for petroleum-based fluids, water, oils, hydrocarbons and MILD chemicals.



**D  
EPDM**  
OK with caustic solutions, dilute acids, ketones and alcohols. Good abrasion resistance.



**HT  
HYTREL + PTFE**  
Widest chemical compatibility, extreme corrosion resistance, non-adhesive, high heat resistance



**MT  
SANTOPRENE + PTFE**  
Widest chemical compatibility, extreme corrosion resistance, non-adhesive, high heat resistance

**N  
NBR**  
Good for petroleum-based fluids, water, oils, hydrocarbons and MILD chemicals.



**D  
EPDM**  
OK with caustic solutions, dilute acids, ketones and alcohols. Good abrasion resistance.



**T  
PTFE**  
Widest chemical compatibility, extreme corrosion resistance, non-adhesive, high heat resistance.



**S  
SS**  
High level of corrosion and abrasion resistance. Good for viscous fluids.





# P

# V

# 1

# -

# AB

## BALL SEAT

## GASKET

## CONNECTIONS

## ATEX ZONE CERTIFICATION

## PORTS



**P**  
**POLYPROPYLENE**  
Wide chemical compatibility.  
General purpose.



**K**  
**PVDF**  
Strong chemical resistance to acids.  
High temperature resistance.



**S**  
**SS**  
High level of corrosion and abrasion resistance.



**Z**  
**PE**  
With high molecular weight: High level of abrasion resistance. (Just D and N balls).



**O**  
**ACETAL**  
Wide range of solvent and hydrocarbons resistance. Good level of abrasion resistance.



**V**  
**VITON**  
High heat resistance.  
Good resistance to aggressive chemicals and hydrocarbons.



**N**  
**NBR**  
Good for petroleum-based fluids, water, oils, hydrocarbons and MILD chemicals.



**D**  
**EPDM**  
Good with caustic solutions, dilute acids, ketones and alcohols.  
Good abrasion resistance.



**T**  
**PTFE**  
Widest chemical compatibility, extreme corrosion resistance, non-adhesive, high heat resistance.

**1**

BSP THREADED

**A**

BSP THREADED WITH REINFORCED RING

**2**

FLANGED

**3**

TRI-CLAMP (PHOENIX FOOD)

**5**

NPT THREADED

**E**

NPT THREADED WITH REINFORCED RING

**6**

DIN 11851/3 (PHOENIX FOOD)



-  
ATEX ZONE 2  
From P4 to P120 models  
⊕ II 3/3 G Ex h IIC T4 Gc  
⊕ II 3 D Ex h IIIB T135°C Dc X  
From P170 to P1000 models  
⊕ II 3/3 G Ex h IIB T4 Gc  
⊕ II 3 D Ex h IIIB T135°C Dc X

**X**

ATEX ZONE 1  
From P4 to P120 models  
⊕ II 2/2 G Ex h IIC T4 Gb  
⊕ II 2 D Ex h IIIB T135°C Db X  
From P170 to P1000 models  
⊕ II 2/2 G Ex h IIB T4 Gb  
⊕ II 2 D Ex h IIIB T135°C Db X

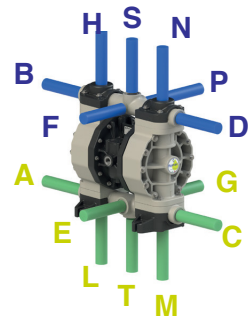

# TABLE CODE

### SPECIAL FEATURES

- SP STAINSTEEL PHOENIX** CENTRAL BLOCK IN SS
- SCP STROKE COUNTER PHOENIX** WITH EXTERNAL PNEUMATIC SIGNAL
- PCR PHOENIX** WITH SHORTER STROKES
- PCL PHOENIX** WITH LONGER STROKES

# PUMP SELECTION

To select the right FLUIMAC pump for your application, the following factors should be considered to achieve economy of operation, long pump life, and minimal maintenance costs:

- The nature of the medium to be pumped, its viscosity, and the solids content
- Pumping capacity in relation to the desired output
- Suction and pressure conditions

Considering these parameters, an optimal pump size is selected when the intersection of the intended installation “pressure vs. flow rate” is near the middle section of the curves.

## USING PERFORMANCE CURVES

To determine compressed air requirements and proper size for a FLUIMAC AODD pump, two elements of information are required:

- 1 Required Flow Rate
- 2 Total Delivery Head

As an example, consider a P170 pump performance curve, pumping about 135 l/min at 25m. Point A on the performance curve is where the desired Flow Rate and Total Delivery Head points intersect. This point determines compressed air requirements for the particular pump. At performance point A, the pump will require approximately 7 bar air inlet pressure. To arrive at this figure, follow the solid blue curve to the left to read the air pressure rating in BAR. By looking at the nearest green curve, it is determined the pump will require approximately 900 nl/min (Normal Liter per minute) of air consumption

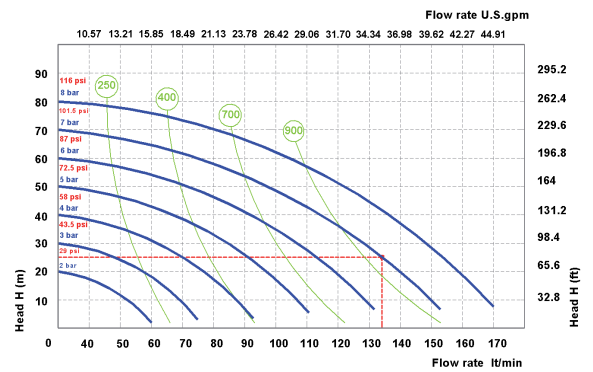

## SPECIFIED SUCTION LIFT

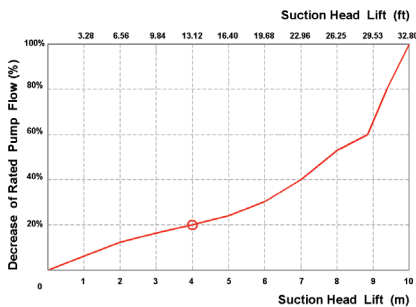

With a suction lift of 4 m, pump rate decreases by approximately 20%. Valid for pumps 3/4" and larger; data varies with pump configuration.

## VISCOUS LIQUIDS PERFORMANCE DATA

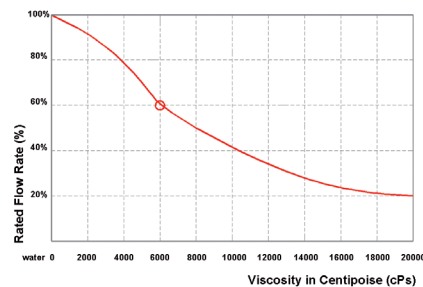

During the conveyance of a fluid with a viscosity of 6000cPs, the pump rate decreases to 60% of its rated value (100% = water). Valid for 3/4" pumps & larger.

PUMP TYPE	AODD	CENTRIFUGAL	LOBE	GEAR	SCREW	PERISTALTIC	PISTON
Variable Flow & Head Control	✓	✓	✓	✓	!	✓	✓
Deadhead Safely	✓	✓	!	!	!	!	!
Dry-Running	✓	✗	✗	✗	✗	✓	✗
Dry Self-Priming	✓	✗	✗	✓	✗	✓	!
No Mechanical Alignment	✓	✗	✗	✗	✗	✗	✗
No Electrical Installation	✓	✗	✗	✗	✗	✗	✗
Portability	✓	✓	!	!	!	✓	!
Submersible	✓	!	✗	✗	✗	✗	!
Sealless	✓	!	!	!	!	✓	!
Cavitation Tolerance	✓	✗	!	!	✓	✓	!
Low Shear & Degradation	✓	✗	✓	✓	!	✓	!

✓ = Suitable ! = Limitations ✗ = Not Recommended



# PHOENIX

**MATERIALS OF CONSTRUCTION:**  
PP, PVDF+CF, ALUMINIUM, SS AISI 316, POMc  
Flow-rate from 4 lt/min to 1.050 lt/min

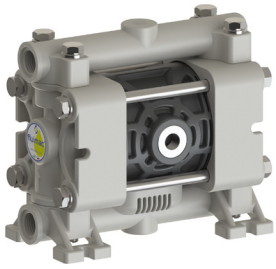

PP



PVDF+CF

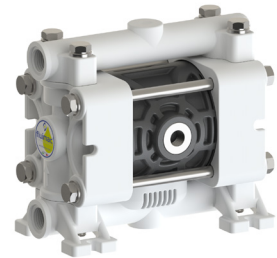

POMc

## TECHNICAL DATA

Fluid connections	<b>1/4" BSPP</b>
Air connection	<b>1/8" BSPP</b>
Max. Flow rate	<b>4 lt/min</b>
Max air pressure	<b>6 bar</b>
Max delivery head	<b>60 mt</b>
Max Suction Lift Dry	<b>3 mt</b>
Max Suction Lift Wet	<b>9,8 mt</b>
Max Solid passing	<b>2 mm</b>
Noise level:	<b>62 dB</b>
Max Viscosity:	<b>5000 cps</b>
Displacement per Stroke:	<b>18 CC ~</b>

Ⓜ II 3/3 G Ex h IIC T4 Gc  
 Ⓜ II 3 D Ex h IIIB T135°C Dc X

Displacement per stroke may vary based on suction condition, discharge head, air pressure and fluid type.

## PERFORMANCE

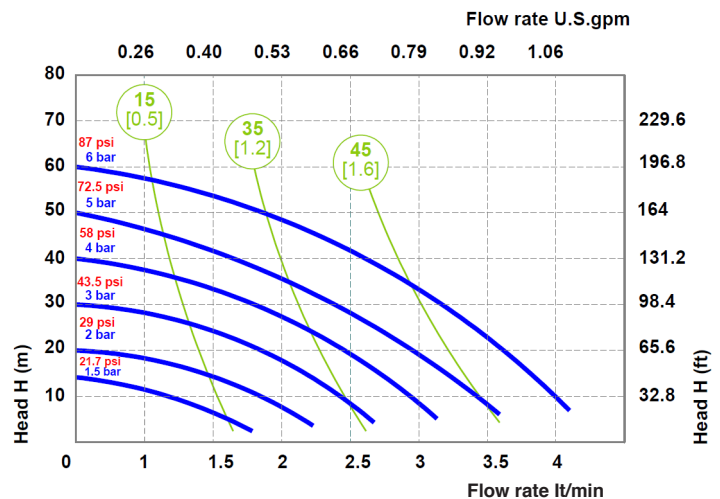

○ Air supply pressure  
 ○ Air consumption Nit/min [SCFM]

The curves and performance values refer to pumps with submerged suction and a free delivery outlet with water at 20°C. These data may vary according to the construction materials and hydraulic conditions.

## DIMENSIONS

	A	B	C	Net Weight	Temperature
PP	129 mm	67 mm	112 mm	0,84 kg	- 4 °C + 65 °C
PVDF	129 mm	67 mm	112 mm	0,84 kg	- 20 °C + 95 °C
POMc	129 mm	67 mm	112 mm	0,84 kg	- 5 °C + 80 °C

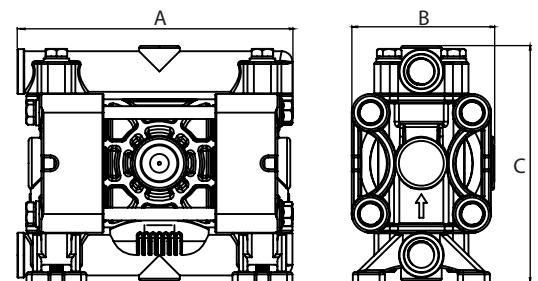

## COMPOSITION

MODEL	CASING	DIAPHRAGM	BALLS	SEATS	GASKET	CONNECTIONS	ATEX	PORTS
P0004	P = PP KC = PVDF+CF O = POMc	NT = NBR+PTFE	T = PTFE S = SS	P = PP K = PVDF O = POMc	D = EPDM V = VITON N = NBR T = PTFE	1 = BSP A = BSP WITH RING 5 = NPT E = NPT WITH RING	- = zone 2	AB = STANDARD

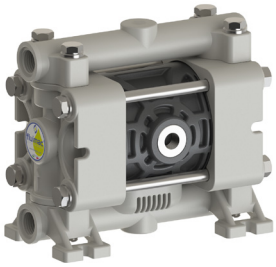

PP



PVDF+CF

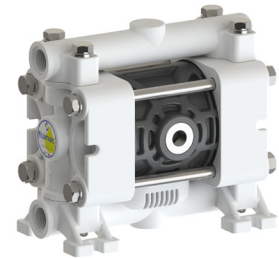

POMc

## TECHNICAL DATA

Fluid connections	<b>1/4" BSPP</b>
Air connection	<b>1/8" BSPP</b>
Max. Flow rate	<b>7 lt/min</b>
Max air pressure	<b>6 bar</b>
Max delivery head	<b>60 mt</b>
Max Suction Lift Dry	<b>3 mt</b>
Max Suction Lift Wet	<b>9,8 mt</b>
Max Solid passing	<b>2 mm</b>
Noise level:	<b>62 dB</b>
Max Viscosity:	<b>5000 cps</b>
Displacement per Stroke:	<b>18 CC ~</b>

II 3/3 G Ex h IIC T4 Gc  
II 3 D Ex h IIIB T135°C Dc X

Displacement per stroke may vary based on suction condition, discharge head, air pressure and fluid type.

## PERFORMANCE

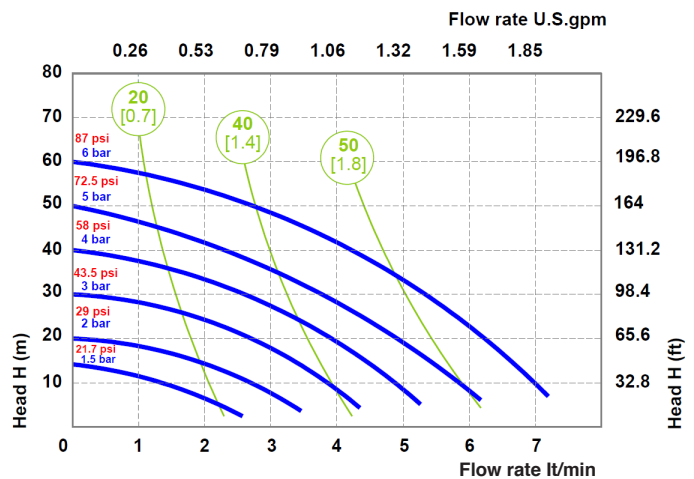

○ Air supply pressure  
○ Air consumption Nit/min [SCFM]

The curves and performance values refer to pumps with submerged suction and a free delivery outlet with water at 20°C. These data may vary according to the construction materials and hydraulic conditions.

## DIMENSIONS

	A	B	C	Net Weight	Temperature
PP	129 mm	67 mm	112 mm	0,84 kg	- 4 °C + 65 °C
PVDF	129 mm	67 mm	112 mm	0,84 kg	- 20 °C + 95 °C
POMc	129 mm	67 mm	112 mm	0,84 kg	- 5 °C + 80 °C

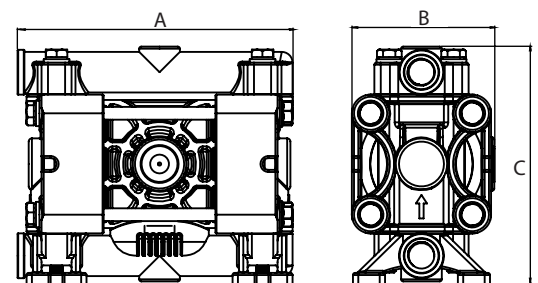

## COMPOSITION

MODEL	CASING	DIAPHRAGM	BALLS	SEATS	GASKET	CONNECTIONS	ATEX	PORTS
P0008	P = PP KC = PVDF+CF O = POMc	NT = NBR+PTFE	T = PTFE S = SS	P = PP K = PVDF O = POMc	D = EPDM V = VITON N = NBR T = PTFE	1 = BSP A = BSP WITH RING 5 = NPT E = NPT WITH RING	-- zone 2	AB = STANDARD

# P 20

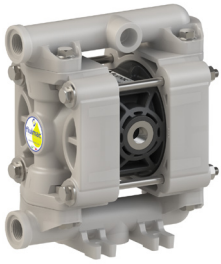

PP



PVDF+CF

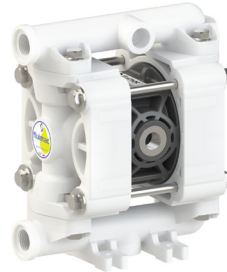

POMc

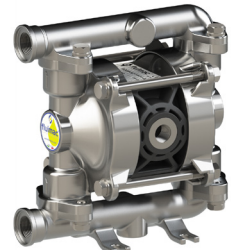

SS

## TECHNICAL DATA

Fluid connections	<b>3/8" BSPP</b>
Air connection	<b>1/4" BSPP</b>
Max. Flow rate	<b>20 lt/min</b>
Max air pressure	<b>7 bar</b>
Max delivery head	<b>70 m</b>
Max Suction Lift Dry	<b>5 m</b>
Max Suction Lift Wet	<b>9,8 m</b>
Max Solid passing	<b>2,5 mm</b>
Noise level:	<b>65 dB</b>
Max Viscosity:	<b>10.000 cps</b>
Displacement per Stroke:	<b>30 CC ~</b>

Ⓜ II 3/3 G Ex h IIC T4 Gc  
 Ⓜ II 3 D Ex h IIIB T135°C Dc X

Displacement per stroke may vary based on suction condition, discharge head, air pressure and fluid type.

## PERFORMANCE

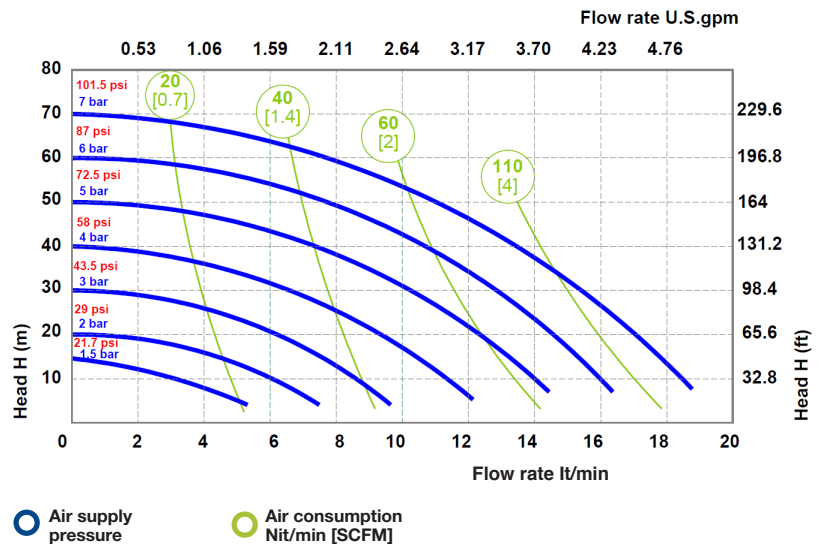

The curves and performance values refer to pumps with submerged suction and a free delivery outlet with water at 20°C. These data may vary according to the construction materials and hydraulic conditions.

## DIMENSIONS

	A	B	C	Net Weight	Temperature
PP	147 mm	93 mm	170 mm	1,3 kg	- 4 °C   + 65 °C
PVDF	147 mm	93 mm	170 mm	1,6 kg	- 20 °C   + 95 °C
POMc	147 mm	93 mm	170 mm	1,5 kg	- 5 °C   + 80 °C
SS	148 mm	85 mm	152 mm	2,3 kg	- 20 °C   + 95 °C

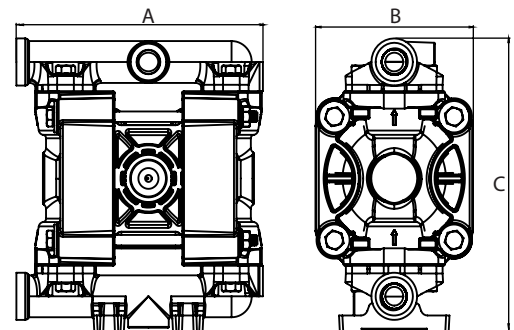

## COMPOSITION

MODEL	CASING	DIAPHRAGM	BALLS	SEATS	GASKET	CONNECTIONS	ATEX	PORTS
P0020	P = PP KC = PVDF+CF O = POMc S = SS	HT = HYTREL+PTFE MT = SANTOPRENE+PTFE H = HYTREL W = SANTOPRENE H.R	T = PTFE S = SS	P = PP K = PVDF O = POMc S = SS	D = EPDM V = VITON N = NBR T = PTFE	1 = BSP A = BSP WITH RING 5 = NPT E = NPT WITH RING	- = zone 2	AB = STANDARD

# P 35

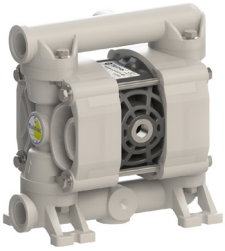

PP



PVDF+CF



ALU



SS

## TECHNICAL DATA

Fluid connections	<b>1/2" BSPP</b>
Air connection	<b>1/4" BSPP</b>
Max. Flow rate	<b>35 lt/min</b>
Max air pressure	<b>7 bar</b>
Max delivery head	<b>70 m</b>
Max Suction Lift Dry	<b>5 m</b>
Max Suction Lift Wet	<b>9,8 m</b>
Max Solid passing	<b>3 mm</b>
Noise level:	<b>65 dB</b>
Max Viscosity:	<b>15.000 cps</b>
Displacement per Stroke:	<b>65 CC ~</b>

II 3/3 G Ex h IIC T4 Gc  
 II 3 D Ex h IIIB T135°C Dc X

Displacement per stroke may vary based on suction condition, discharge head, air pressure and fluid type.

## PERFORMANCE

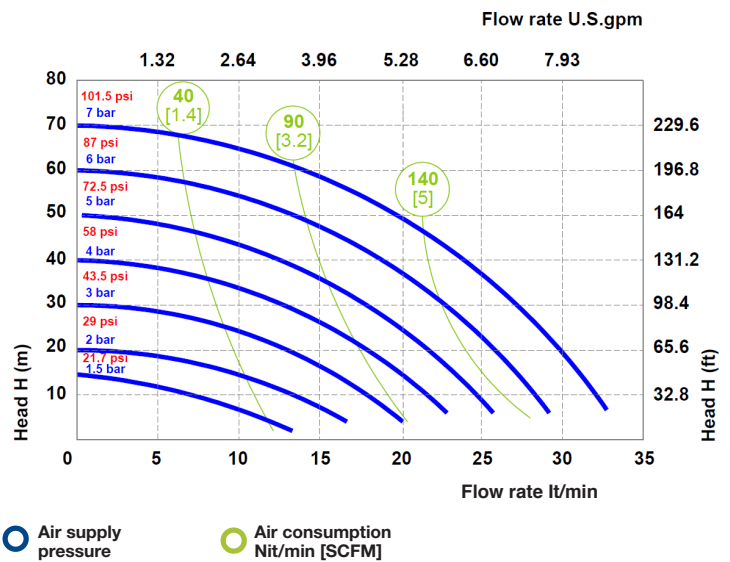

The curves and performance values refer to pumps with submerged suction and a free delivery outlet with water at 20°C. These data may vary according to the construction materials and hydraulic conditions.

## DIMENSIONS

	A	B	C	Net Weight	Temperature
PP	177 mm	105 mm	186 mm	1,8 kg	- 4 °C   + 65 °C
PVDF	177 mm	105 mm	186 mm	2,3 kg	- 20 °C   + 95 °C
ALU	183 mm	110 mm	189 mm	2,8 kg	- 20 °C   + 95 °C
SS	181 mm	106 mm	192 mm	3,8 kg	- 20 °C   + 95 °C

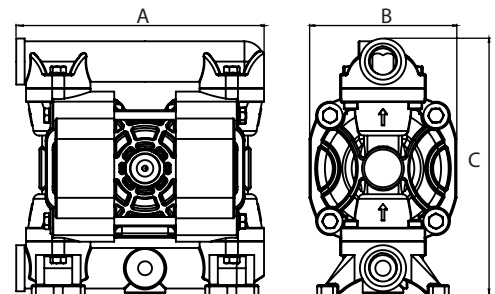

## COMPOSITION

MODEL	CASING	DIAPHRAGM	BALLS	SEATS	GASKET	CONNECTIONS	ATEX	PORTS
<b>P0035</b>	P = PP KC = PVDF+CF A = ALU S = SS	HT = HYTREL+PTFE MT = SANTOPRENE+PTFE H = HYTREL W = SANTOPRENE H.R.	T = PTFE S = SS D = EPDM N = NBR	P = PP K = PVDF O = POMc Z = PE-UHMWE S = SS	D = EPDM V = VITON N = NBR T = PTFE	1 = BSP A = BSP WITH RING 5 = NPT E = NPT WITH RING	- = zone 2	AB = STANDARD

# P 55



PP



PVDF+CF



ALU



SS

## TECHNICAL DATA

Fluid connections	<b>1/2" BSPP</b>
Air connection	<b>1/4" BSPP</b>
Max. Flow rate	<b>55 lt/min</b>
Max air pressure	<b>8 bar</b>
Max delivery head	<b>80 m</b>
Max Suction Lift Dry	<b>5 m</b>
Max Suction Lift Wet	<b>9,8 m</b>
Max Solid passing	<b>3,5 mm</b>
Noise level:	<b>70 dB</b>
Max Viscosity:	<b>15.000 cps</b>
Displacement per Stroke:	<b>140 CC ~</b>

II 3/3 G Ex h IIC T4 Gc  
 II 3 D Ex h IIIB T135°C Dc X

Displacement per stroke may vary based on suction condition, discharge head, air pressure and fluid type.

## PERFORMANCE

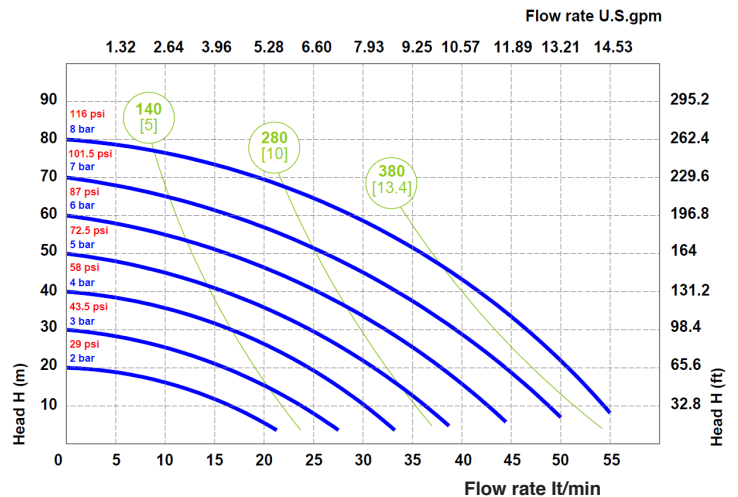

The curves and performance values refer to pumps with submerged suction and a free delivery outlet with water at 20°C. These data may vary according to the construction materials and hydraulic conditions.

## DIMENSIONS

	A	B	C	Net Weight	Temperature
PP	238 mm	156 mm	249 mm	3,8 kg	- 4 °C   + 65 °C
PVDF	238 mm	156 mm	249 mm	4,8 kg	- 20 °C   + 95 °C
ALU	234 mm	156 mm	245 mm	3,8 kg	- 20 °C   + 95 °C
SS	234 mm	156 mm	269 mm	6,8 kg	- 20 °C   + 95 °C

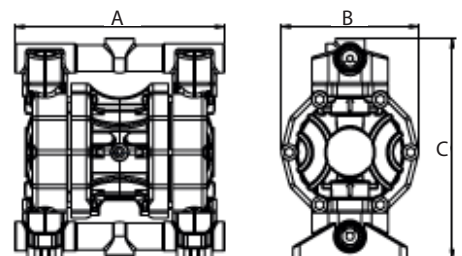

## COMPOSITION

MODEL	CASING	DIAPHRAGM	BALLS	SEATS	GASKET	CONNECTIONS	ATEX	PORTS
P0055	P = PP KC = PVDF+CF S = SS A = ALU	HT = HYTREL+PTFE MT = SANTOPRENE+PTFE H = HYTREL W = SANTOPRENE H.R. D = EPDM N = NBR	T = PTFE S = SS D = EPDM N = NBR	P = PP K = PVDF S = SS Z = PE-UHMWE	D = EPDM V = VITON N = NBR T = PTFE	1 = BSP A = BSP WITH RING 5 = NPT E = NPT WITH RING	- = zone 2	AB = STANDARD



# P 60



PP



PVDF+CF



ALU



SS

## TECHNICAL DATA

Fluid connections	<b>1/2" BSPP</b>
Air connection	<b>1/4" BSPP</b>
Max. Flow rate	<b>65 lt/min</b>
Max air pressure	<b>8 bar</b>
Max delivery head	<b>80 m</b>
Max Suction Lift Dry	<b>5 m</b>
Max Suction Lift Wet	<b>9,8 m</b>
Max Solid passing	<b>3,5 mm</b>
Noise level:	<b>72 dB</b>
Max Viscosity:	<b>20.000 cps</b>
Displacement per Stroke:	<b>140 CC ~</b>

II 3/3 G Ex h IIC T4 Gc  
 II 3 D Ex h IIIB T135°C Dc X

Displacement per stroke may vary based on suction condition, discharge head, air pressure and fluid type.

## PERFORMANCE

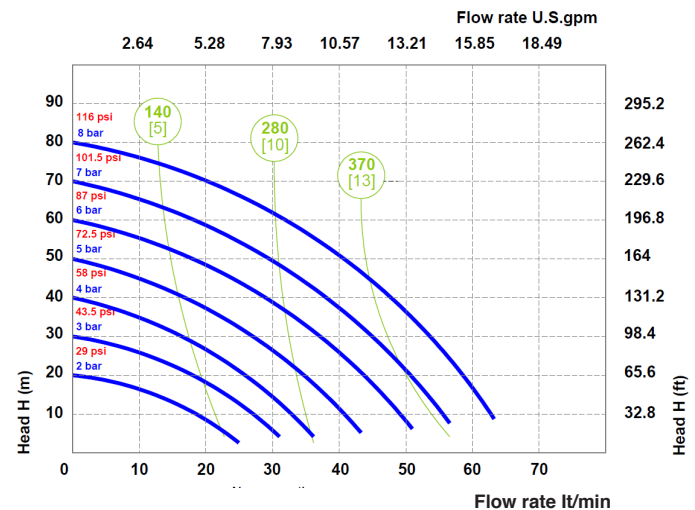

The curves and performance values refer to pumps with submerged suction and a free delivery outlet with water at 20°C. These data may vary according to the construction materials and hydraulic conditions.

## DIMENSIONS

	A	B	C	Net Weight	Temperature
PP	238 mm	165 mm	249 mm	4,3 kg	- 4 °C   + 65 °C
PVDF	238 mm	165 mm	249 mm	5,3 kg	- 20 °C   + 95 °C
ALU	234 mm	165 mm	245 mm	4,3 kg	- 20 °C   + 95 °C
SS	234 mm	165 mm	269 mm	7,3 kg	- 20 °C   + 95 °C

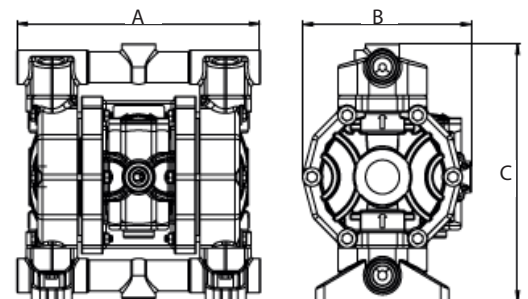

## COMPOSITION

MODEL	CASING	DIAPHRAGM	BALLS	SEATS	GASKET	CONNECTIONS	ATEX	PORTS
P0060	P = PP KC = PVDF+CF S = SS A = ALU	HT = HYTREL+PTFE MT = SANTOPRENE+PTFE H = HYTREL W = SANTOPRENE H.R. D = EPDM N = NBR	T = PTFE S = SS D = EPDM N = NBR	P = PP K = PVDF S = SS Z = PE-UHMWE	D = EPDM V = VITON N = NBR T = PTFE	1 = BSP A = BSP WITH RING 2 = FLANGED 5 = NPT E = NPT WITH RING	- = zone 2	AB = STANDARD

# P 90

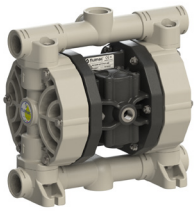

PP



PVDF+CF



ALU

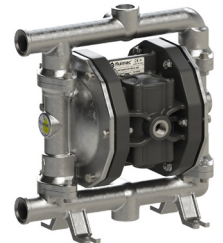

SS

## TECHNICAL DATA

Fluid connections	<b>3/4" BSPP</b>
Air connection	<b>3/8" BSPP</b>
Max. Flow rate	<b>100 lt/mm</b>
Max air pressure	<b>8 bar</b>
Max delivery head	<b>80 m</b>
Max Suction Lift Dry	<b>5 m</b>
Max Suction Lift Wet	<b>9,8 m</b>
Max Solid passing	<b>4 mm</b>
Noise level:	<b>72 dB</b>
Max Viscosity:	<b>25.000 cps</b>
Displacement per Stroke:	<b>200 CC ~</b>

Ⓜ II 3/3 G Ex h IIC T4 Gc  
 Ⓜ II 3 D Ex h IIIB T135°C Dc X

Displacement per stroke may vary based on suction condition, discharge head, air pressure and fluid type.

## PERFORMANCE

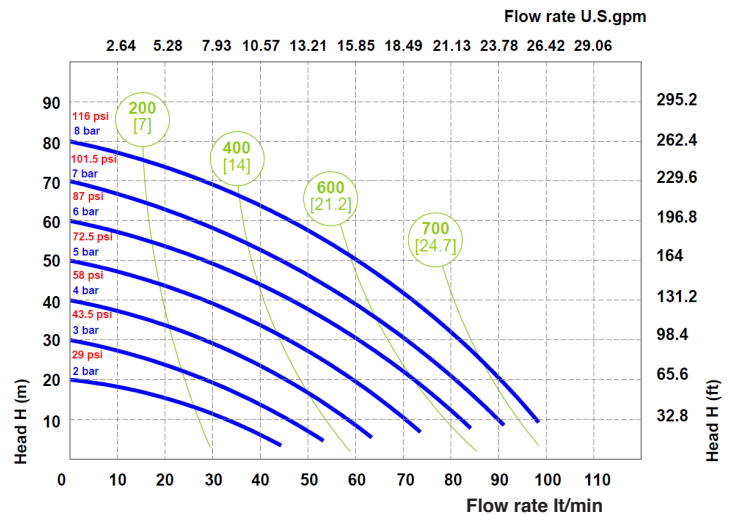

The curves and performance values refer to pumps with submerged suction and a free delivery outlet with water at 20°C. These data may vary according to the construction materials and hydraulic conditions.

## DIMENSIONS

	A	B	C	Net Weight	Temperature
PP	293 mm	179 mm	267 mm	5,1 kg	- 4 °C   + 65 °C
PVDF	293 mm	179 mm	267 mm	6,6 kg	- 20 °C   + 95 °C
ALU	293 mm	178 mm	290 mm	5,6 kg	- 20 °C   + 95 °C
SS	280 mm	178 mm	291 mm	7,6 kg	- 20 °C   + 95 °C

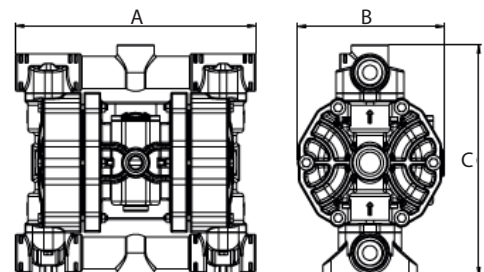

## COMPOSITION

MODEL	CASING	DIAPHRAGM	BALLS	SEATS	GASKET	CONNECTIONS	ATEX	PORTS
P0090	P = PP KC = PVDF+CF S = SS A = ALU	HT = HYTREL+PTFE MT = SANTOPRENE+PTFE H = HYTREL W = SANTOPRENE H.R. D = EPDM N = NBR	T = PTFE S = SS D = EPDM N = NBR	P = PP K = PVDF S = SS Z = PE-UHMWE	D = EPDM V = VITON N = NBR T = PTFE	1 = BSP A = BSP WITH RING 2 = FLANGED 5 = NPT E = NPT WITH RING	- = zone 2	AB = STANDARD

# P 120



PP



PVDF+CF



ALU

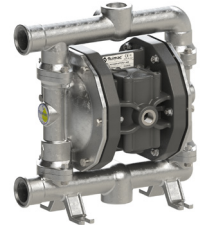

SS

## TECHNICAL DATA

Fluid connections	<b>1" BSPP</b>
Air connection	<b>3/8" BSPP</b>
Max. Flow rate	<b>120 lt/mm</b>
Max air pressure	<b>8 bar</b>
Max delivery head	<b>80 m</b>
Max Suction Lift Dry	<b>5 m</b>
Max Suction Lift Wet	<b>9,8 m</b>
Max Solid passing	<b>4 mm</b>
Noise level:	<b>72 dB</b>
Max Viscosity:	<b>25.000 cps</b>
Displacement per Stroke:	<b>200 CC ~</b>

II 3/3 G Ex h IIC T4 Gc  
 II 3 D Ex h IIIB T135°C Dc X

Displacement per stroke may vary based on suction condition, discharge head, air pressure and fluid type.

## PERFORMANCE

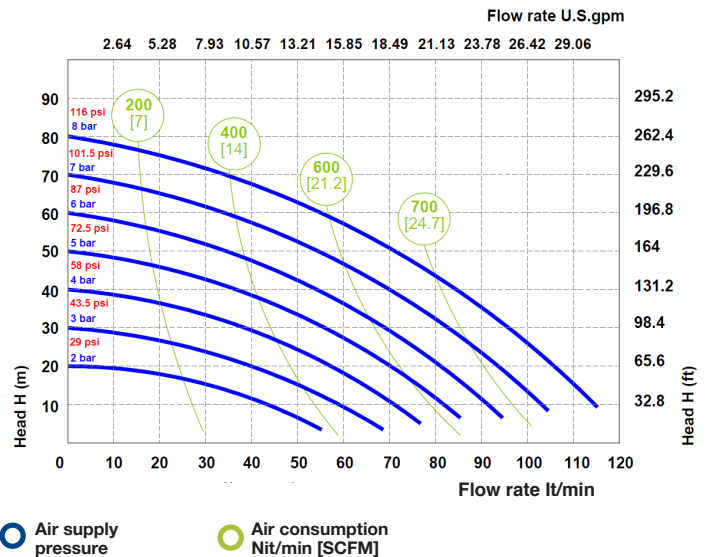

The curves and performance values refer to pumps with submerged suction and a free delivery outlet with water at 20°C. These data may vary according to the construction materials and hydraulic conditions.

## DIMENSIONS

	A	B	C	Net Weight	Temperature
PP	293 mm	179 mm	280 mm	5,6 kg	- 4 °C   + 65 °C
PVDF	293 mm	179 mm	280 mm	7,6 kg	- 20 °C   + 95 °C
ALU	293 mm	178 mm	301 mm	5,6 kg	- 20 °C   + 95 °C
SS	280 mm	178 mm	291 mm	9,6 kg	- 20 °C   + 95 °C

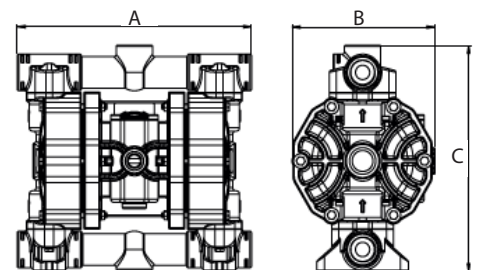

## COMPOSITION

MODEL	CASING	DIAPHRAGM	BALLS	SEATS	GASKET	CONNECTIONS	ATEX	PORTS
<b>P0120</b>	P = PP KC = PVDF+CF S = SS A = ALU	HT = HYTREL+PTFE MT = SANTOPRENE+PTFE H = HYTREL W = SANTOPRENE H.R. D = EPDM N = NBR	T = PTFE S = SS D = EPDM N = NBR	P = PP K = PVDF S = SS Z = PE-UHMWE	D = EPDM V = VITON N = NBR T = PTFE	1 = BSP A = BSP WITH RING 2 = FLANGED 5 = NPT E = NPT WITH RING	- = zone 2	AB = STANDARD

# P 170



PP



PVDF+CF



ALU (P 160)



SS

## TECHNICAL DATA

Fluid connections	<b>1" BSPP-DN25</b>
Air connection	<b>1/2" BSPP</b>
Max. Flow rate	<b>170 lt/mm</b>
Max air pressure	<b>8 bar</b>
Max delivery head	<b>80 m</b>
Max Suction Lift Dry	<b>5 m</b>
Max Suction Lift Wet	<b>9,8 m</b>
Max Solid passing	<b>7,5 mm</b>
Noise level:	<b>75 dB</b>
Max Viscosity:	<b>35.000 cps</b>
Displacement per Stroke:	<b>700 CC ~</b>

Ⓢ II 3/3 G Ex h IIB T4 Gc  
 Ⓢ II 3 D Ex h IIB T135°C Dc X

Displacement per stroke may vary based on suction condition, discharge head, air pressure and fluid type.

## PERFORMANCE

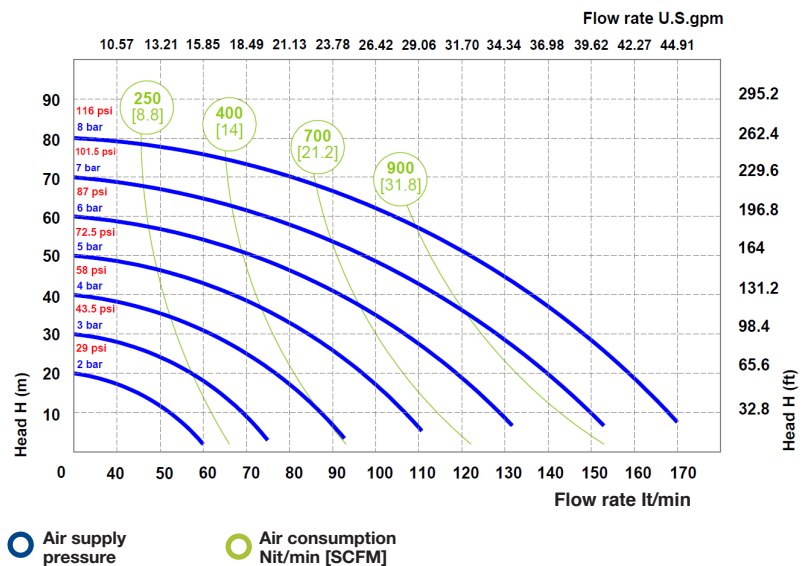

The curves and performance values refer to pumps with submerged suction and a free delivery outlet with water at 20°C. These data may vary according to the construction materials and hydraulic conditions.

## DIMENSIONS

	A	B	C	Net Weight	Temperature
PP	430 mm	222 mm	414 mm	14,2 kg	- 4 °C   + 65 °C
PVDF	430 mm	222 mm	414 mm	16,2 kg	- 20 °C   + 95 °C
ALU	370 mm	222 mm	364 mm	13,2 kg	- 20 °C   + 95 °C
SS	357 mm	222 mm	371 mm	17,2 kg	- 20 °C   + 95 °C

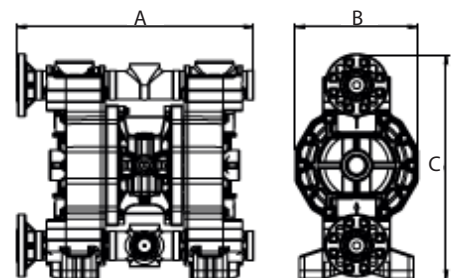

## COMPOSITION

MODEL	CASING	DIAPHRAGM	BALLS	SEATS	GASKET	CONNECTIONS	ATEX	PORTS
<b>P0170</b> <b>P0160</b> <b>(ONLY ALU)</b>	P = PP KC = PVDF+CF S = SS A = ALU	HT = HYTREL+PTFE MT = SANTOPRENE+PTFE H = HYTREL W = SANTOPRENE H.R. D = EPDM N = NBR	T = PTFE S = SS D = EPDM N = NBR	P = PP K = PVDF S = SS Z = PE-UHMWE	D = EPDM V = VITON N = NBR T = PTFE	1 = BSP 2 = FLANGED 5 = NPT	- = zone 2	AB = STANDARD

# P 252



PP



PVDF+CF



ALU (P 250)

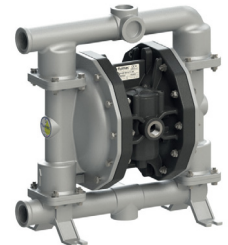

SS

## TECHNICAL DATA

Fluid connections	<b>1"1/4" BSPP</b>
Air connection	<b>1/2" BSPP</b>
Max. Flow rate	<b>250 lt/min</b>
Max air pressure	<b>8 bar</b>
Max delivery head	<b>80 m</b>
Max Suction Lift Dry	<b>5 m</b>
Max Suction Lift Wet	<b>9,8 m</b>
Max Solid passing	<b>7,5 mm</b>
Noise level:	<b>75 dB</b>
Max Viscosity:	<b>35.000 cps</b>
Displacement per Stroke:	<b>700 CC ~</b>

Ⓜ II 3/3 G Ex h IIB T4 Gc  
 Ⓜ II 3 D Ex h IIB T135°C Dc X

Displacement per stroke may vary based on suction condition, discharge head, air pressure and fluid type.

## PERFORMANCE

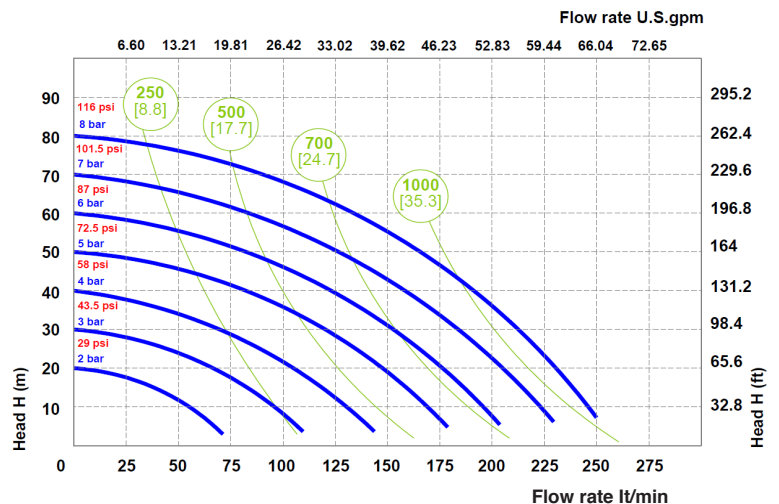

⊙ Air supply pressure      ⊙ Air consumption Nit/min [SCFM]

The curves and performance values refer to pumps with submerged suction and a free delivery outlet with water at 20°C. These data may vary according to the construction materials and hydraulic conditions.

## DIMENSIONS

	A	B	C	Net Weight	Temperature
PP	396 mm	222 mm	388 mm	14,2 kg	- 4 °C   + 65 °C
PVDF	396 mm	222 mm	388 mm	16,2 kg	- 20 °C   + 95 °C
ALU	370 mm	222 mm	365 mm	13,2 kg	- 20 °C   + 95 °C
SS	357 mm	222 mm	371 mm	17,2 kg	- 20 °C   + 95 °C

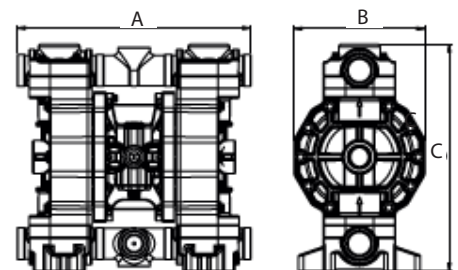

## COMPOSITION

MODEL	CASING	DIAPHRAGM	BALLS	SEATS	GASKET	CONNECTIONS	ATEX	PORTS
<b>P0252</b> <b>P0250</b> <b>(ONLY ALU)</b>	P = PP KC = PVDF+CF S = SS A = ALU	HT = HYTREL+PTFE MT = SANTOPRENE+PTFE H = HYTREL W = SANTOPRENE H.R. D = EPDM N = NBR	T = PTFE S = SS D = EPDM N = NBR	P = PP K = PVDF S = SS Z = PE-UHMWE	D = EPDM V = VITON N = NBR T = PTFE	1 = BSP A = BSP WITH RING 2 = FLANGED 5 = NPT E = NPT WITH RING	- = zone 2	AB = STANDARD

# P 400

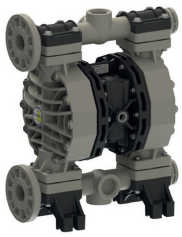

PP



PVDF+CF



ALU



SS

## TECHNICAL DATA

Fluid connections	<b>1 1/2" BSPP-DN 40</b>
Air connection	<b>1/2" BSPP</b>
Max. Flow rate	<b>380 lt/min</b>
Max air pressure	<b>8 bar</b>
Max delivery head	<b>80 m</b>
Max Suction Lift Dry	<b>5 m</b>
Max Suction Lift Wet	<b>9,8 m</b>
Max Solid passing	<b>8 mm</b>
Noise level:	<b>78 dB</b>
Max Viscosity:	<b>40.000 cps</b>
Displacement per Stroke:	<b>1200 CC ~</b>

Ⓢ II 3/3 G Ex h IIB T4 Gc  
 Ⓢ II 3 D Ex h IIB T135°C Dc X

Displacement per stroke may vary based on suction condition, discharge head, air pressure and fluid type.

## PERFORMANCE

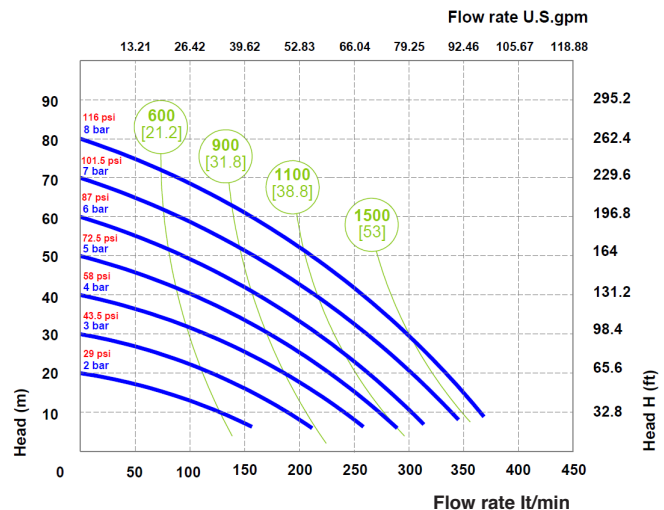

○ Air supply pressure  
 ○ Air consumption Nit/min [SCFM]

The curves and performance values refer to pumps with submerged suction and a free delivery outlet with water at 20°C. These data may vary according to the construction materials and hydraulic conditions.

## DIMENSIONS

	A	B	C	Net Weight	Temperature
PP	454 mm	260 mm	564 mm	18,2 kg	- 4 °C   + 65 °C
PVDF	454 mm	260 mm	564 mm	22,2 kg	- 20 °C   + 95 °C
ALU	444 mm	260 mm	563 mm	22,2 kg	- 20 °C   + 95 °C
SS	361 mm	260 mm	502 mm	25,3 kg	- 20 °C   + 95 °C

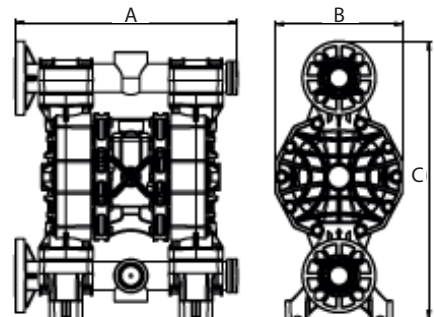

## COMPOSITION

MODEL	CASING	DIAPHRAGM	BALLS	SEATS	GASKET	CONNECTIONS	ATEX	PORTS
<b>P0400</b>	P = PP KC = PVDF+CF S = SS A = ALU	HT = HYTREL+PTFE MT = SANTOPRENE+PTFE H = HYTREL W = SANTOPRENE H.R. D = EPDM N = NBR	T = PTFE S = SS D = EPDM N = NBR	P = PP K = PVDF S = SS Z = PE-UHMWE	D = EPDM V = VITON N = NBR T = PTFE	1 = BSP 2 = FLANGED 5 = NPT	- = zone 2	AB = STANDARD EF = STANDARD SS

# P 700



PP



PVDF+CF

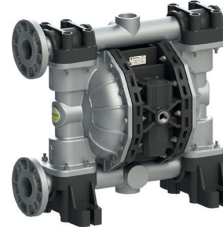

ALU



SS

## TECHNICAL DATA

Fluid connections	<b>2" BSPP-DN 50</b>
Air connection	<b>3/4" BSPP</b>
Max. Flow rate	<b>700 lt/min</b>
Max air pressure	<b>8 bar</b>
Max delivery head	<b>80 m</b>
Max Suction Lift Dry	<b>5 m</b>
Max Suction Lift Wet	<b>9,8 m</b>
Max Solid passing	<b>8,5 mm</b>
Noise level:	<b>78 dB</b>
Max Viscosity:	<b>50.000 cps</b>
Displacement per Stroke:	<b>3050 CC ~</b>

Ⓢ II 3/3 G Ex h IIB T4 Gc  
 Ⓢ II 3 D Ex h IIB T135°C Dc X

Displacement per stroke may vary based on suction condition, discharge head, air pressure and fluid type.

## PERFORMANCE

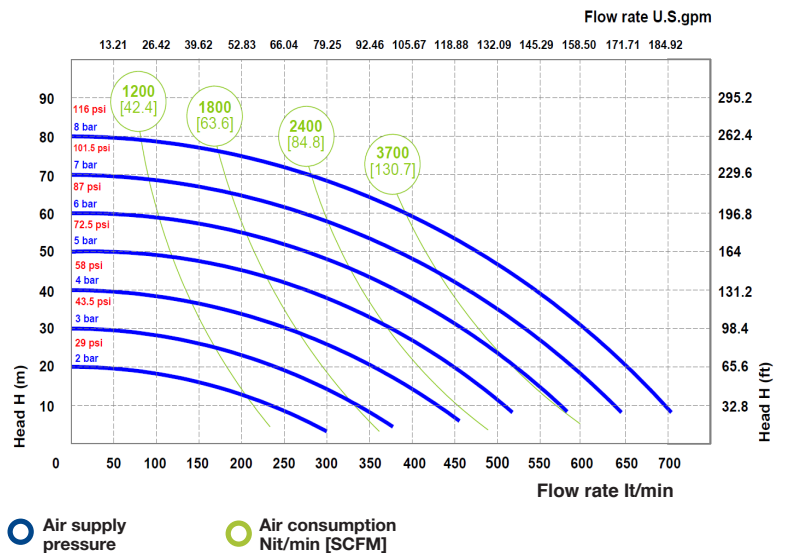

The curves and performance values refer to pumps with submerged suction and a free delivery outlet with water at 20°C. These data may vary according to the construction materials and hydraulic conditions.

## DIMENSIONS

	A	B	C	Net Weight	Temperature
PP	595 mm	345 mm	570 mm	30,6 kg	- 4 °C   + 65 °C
PVDF	595 mm	345 mm	570 mm	41,6 kg	- 20 °C   + 95 °C
ALU	595 mm	340 mm	567 mm	37,6 kg	- 20 °C   + 95 °C
SS	487 mm	340 mm	599 mm	51 kg	- 20 °C   + 95 °C

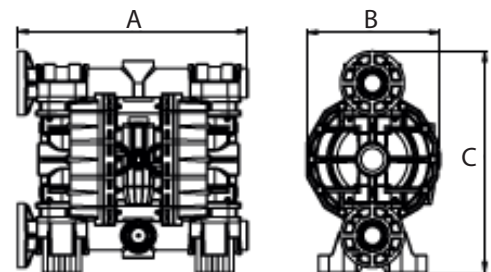

## COMPOSITION

MODEL	CASING	DIAPHRAGM	BALLS	SEATS	GASKET	CONNECTIONS	ATEX	PORTS
<b>P0700</b>	P = PP KC = PVDF+CF S = SS A = ALU	HT = HYTREL+PTFE MT = SANTOPRENE+PTFE H = HYTREL W = SANTOPRENE H.R. D = EPDM N = NBR	T = PTFE S = SS D = EPDM N = NBR	P = PP K = PVDF S = SS Z = PE-UHMWE	D = EPDM V = VITON N = NBR T = PTFE	1 = BSP 2 = FLANGED 5 = NPT	- = zone 2	AB = STANDARD EF = STANDARD SS



PP



PVDF+CF



ALU



SS

## TECHNICAL DATA

Fluid connections	<b>3" BSPP-DN 80</b>
Air connection	<b>3/4" BSPP</b>
Max. Flow rate	<b>1050 lt/min</b>
Max air pressure	<b>8 bar</b>
Max delivery head	<b>80 m</b>
Max Suction Lift Dry	<b>5 m</b>
Max Suction Lift Wet	<b>9,8 m</b>
Max Solid passing	<b>12 mm</b>
Noise level:	<b>82 dB</b>
Max Viscosity:	<b>55.000 cps</b>
Displacement per Stroke:	<b>9750 CC ~</b>

Ⓜ II 3/3 G Ex h IIB T4 Gc  
 Ⓜ II 3 D Ex h IIB T135°C Dc X

Displacement per stroke may vary based on suction condition, discharge head, air pressure and fluid type.

## PERFORMANCE

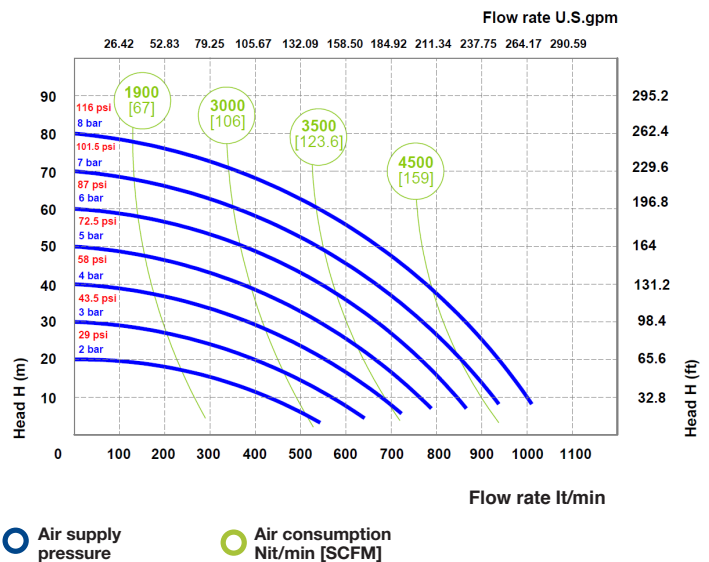

○ Air supply pressure  
 ○ Air consumption Nit/min [SCFM]

The curves and performance values refer to pumps with submerged suction and a free delivery outlet with water at 20°C. These data may vary according to the construction materials and hydraulic conditions.

## DIMENSIONS

	A	B	C	Net Weight	Temperature
PP	780 mm	417 mm	1024 mm	62 kg	- 4 °C   + 65 °C
PVDF	780 mm	417 mm	1024 mm	77 kg	- 20 °C   + 95 °C
ALU	710 mm	417 mm	940 mm	84 kg	- 20 °C   + 95 °C
SS	672 mm	417 mm	946,5 mm	122 kg	- 20 °C   + 95 °C

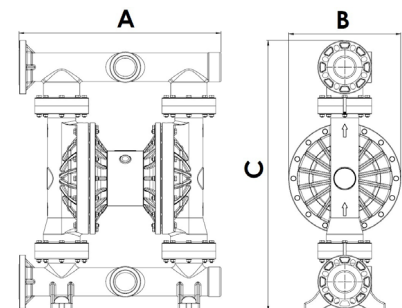

## COMPOSITION

MODEL	CASING	DIAPHRAGM	BALLS	SEATS	GASKET	CONNECTIONS	ATEX	PORTS
<b>P1000</b>	P = PP KC = PVDF+CF S = SS A = ALU	HT = HYTREL+PTFE MT = SANTOPRENE+PTFE H = HYTREL W = SANTOPRENE H.R. D = EPDM N = NBR	T = PTFE S = SS D = EPDM N = NBR	P = PP K = PVDF S = SS Z = PE-UHMWE	D = EPDM V = VITON N = NBR T = PTFE	1 = BSP 2 = FLANGED 5 = NPT	- = zone 2	AB = STANDARD





# PHOENIX FOOD

**MATERIALS OF CONSTRUCTION:**  
SS AISI 316 electro-polished  
Flow-rate from 20lt/min to 1.000 lt/min  
Tri-Clamp Connection.

# PF 20

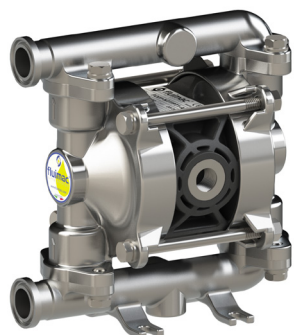

Fluid connections **3/4" TRI-CLAMP  
DN 3/4" BS 4825**

Air connection **6 mm**

Max. Flow rate **20 lt/min**

Max air pressure **7 bar**

Max delivery head **70 m**

Max Suction Lift Dry **5 m**

Max Suction Lift Wet **9,8 m**

Max Solid passing **2,5 mm**

Noise level: **65 dB**

Max Viscosity: **10.000 cps**

Displacement per Stroke: **30 CC ~**

II 3/3 G Ex h IIC T4 Gc  
II 3 D Ex h IIIB T135°C Dc X

Displacement per stroke may vary based on suction condition, discharge head, air pressure and fluid type.

SS ELECTRO-POLISHED

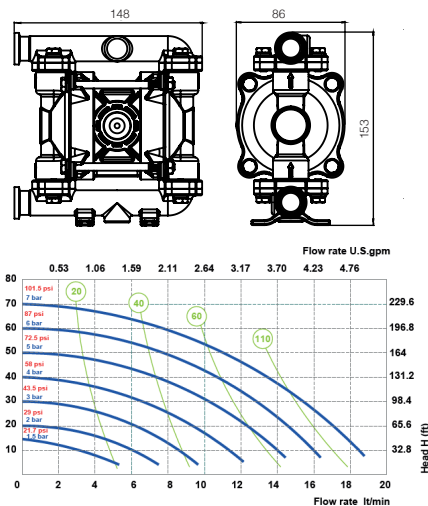

Air supply pressure Air consumption lit/min [SCFM]  
The curves and performance values refer to pumps with submerged suction and free delivery outlet, with water at 20°C. These data may vary according to the construction materials and hydraulic conditions.

Net Weight	Temperature
2,3 kg	- 20 °C +95 °C

MODEL	CASING	DIAPHRAGM	BALLS	SEATS	GASKET	CONNECTIONS	ATEX	PORTS
PF0020	S = SS POLISHED	HT = HYTREL+PTFE	T = PTFE S = SS	S = SS	T = PTFE	3 = TRI-CLAMP 1 = BSP 6 = DIN	- = zone 2 X = zone 1	AB = STANDARD

# PF 35



Fluid connections **1" TRI-CLAMP  
DN 1" BS 4825**

Air connection **6 mm**

Max. Flow rate **35 lt/min**

Max air pressure **7 bar**

Max delivery head **70 m**

Max Suction Lift Dry **5 m**

Max Suction Lift Wet **9,8 m**

Max Solid passing **3 mm**

Noise level: **65 dB**

Max Viscosity: **15.000 cps**

Displacement per Stroke: **65 CC ~**

II 3/3 G Ex h IIC T4 Gc  
II 3 D Ex h IIIB T135°C Dc X

Displacement per stroke may vary based on suction condition, discharge head, air pressure and fluid type.

SS ELECTRO-POLISHED

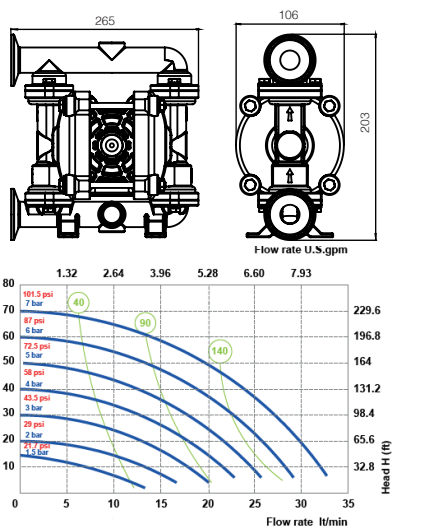

Air supply pressure Air consumption lit/min [SCFM]  
The curves and performance values refer to pumps with submerged suction and free delivery outlet, with water at 20°C. These data may vary according to the construction materials and hydraulic conditions.

Net Weight	Temperature
3,8 kg	- 20 °C +95 °C

MODEL	CASING	DIAPHRAGM	BALLS	SEATS	GASKET	CONNECTIONS	ATEX	PORTS
PF0035	S = SS POLISHED	HT = HYTREL+PTFE	T = PTFE S = SS	S = SS	T = PTFE	3 = TRI-CLAMP 1 = BSP 6 = DIN	- = zone 2 X = zone 1	AB = STANDARD

# PF 60



SS ELECTRO-POLISHED



- Fluid connections **1" TRI-CLAMP  
DN 1" BS 4825**
- Air connection **1/4" BSP**
- Max. Flow rate **65 lt/min**
- Max air pressure **8 bar**
- Max delivery head **80 m**
- Max Suction Lift Dry **5 m**
- Max Suction Lift Wet **9,8 m**
- Max Solid passing **3,5 mm**
- Noise level: **72 dB**
- Max Viscosity: **20.000 cps**
- Displacement per Stroke: **140 CC ~**
- II 3/3 G Ex h IIC T4 Gc
- II 3 D Ex h IIIB T135°C Dc X

Displacement per stroke may vary based on suction condition, discharge head, air pressure and fluid type.

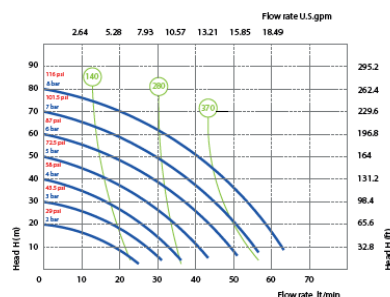
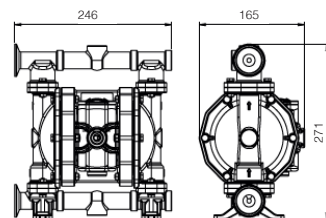

**Air supply pressure** **Air consumption Nit/min [SCFM]**  
The curves and performance values refer to pumps with submerged suction and free delivery outlet, with water at 20°C. These data may vary according to the construction materials and hydraulic conditions.

Net Weight	Temperature
7,3 kg	- 20 °C +95 °C

MODEL	CASING	DIAPHRAGM	BALLS	SEATS	GASKET	CONNECTIONS	ATEX	PORTS
PF0060	S = SS POLISHED	HT = HYTREL+PTFE	T = PTFE S = SS	S = SS	T = PTFE	3 = TRI-CLAMP 1 = BSP 6 = DIN	- = zone 2 X = zone 1	AB = STANDARD

# PF 120

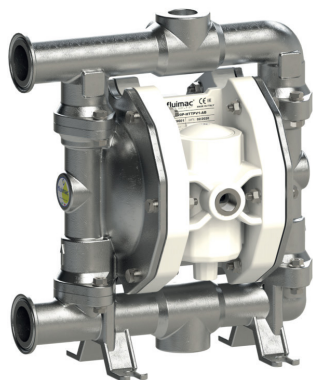

SS ELECTRO-POLISHED



- Fluid connections **1" TRI-CLAMP  
DN 25 ISO 2852**
- Air connection **3/8" BSP**
- Max. Flow rate **120 lt/min**
- Max air pressure **8 bar**
- Max delivery head **80 m**
- Max Suction Lift Dry **5 m**
- Max Suction Lift Wet **9,8 m**
- Max Solid passing **4 mm**
- Noise level: **72 dB**
- Max Viscosity: **25.000 cps**
- Displacement per Stroke: **200 CC ~**
- II 3/3 G Ex h IIC T4 Gc
- II 3 D Ex h IIIB T135°C Dc X

Displacement per stroke may vary based on suction condition, discharge head, air pressure and fluid type.

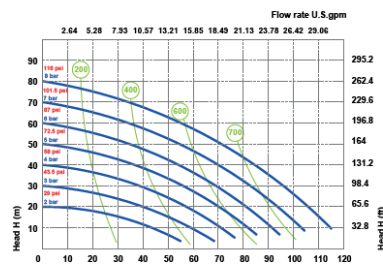
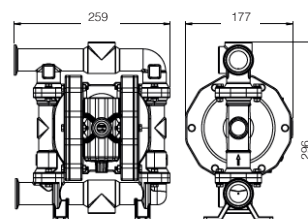

**Air supply pressure** **Air consumption Nit/min [SCFM]**  
The curves and performance values refer to pumps with submerged suction and free delivery outlet, with water at 20°C. These data may vary according to the construction materials and hydraulic conditions.

Net Weight	Temperature
9,6 kg	- 20 °C +95 °C

MODEL	CASING	DIAPHRAGM	BALLS	SEATS	GASKET	CONNECTIONS	ATEX	PORTS
PF0120	S = SS POLISHED	HT = HYTREL+PTFE	T = PTFE S = SS	S = SS	T = PTFE	3 = TRI-CLAMP 1 = BSP 6 = DIN	- = zone 2 X = zone 1	AB = STANDARD

# PF I70

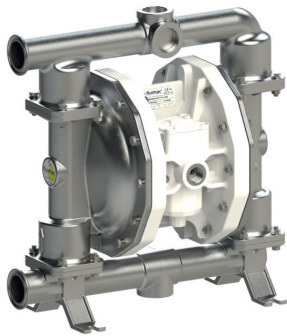

SS ELECTRO-POLISHED



- Fluid connections **1 1/2" TRI-CLAMP  
DN 1 1/2 BS 4825**
- Air connection **1/2" BSP**
- Max. Flow rate **170 lt/min**
- Max air pressure **8 bar**
- Max delivery head **80 m**
- Max Suction Lift Dry **5 m**
- Max Suction Lift Wet **9,8 m**
- Max Solid passing **7,5 mm**
- Noise level: **75 dB**
- Max Viscosity: **35.000 cps**
- Displacement per Stroke: **700 CC ~**

- ⊕ II 3/3 G Ex h IIB T4 Gc
- ⊕ II 3 D Ex h IIIB T135°C Dc X

Displacement per stroke may vary based on suction condition, discharge head, air pressure and fluid type.

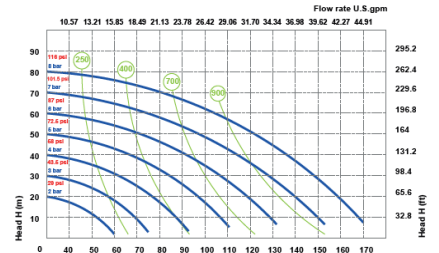
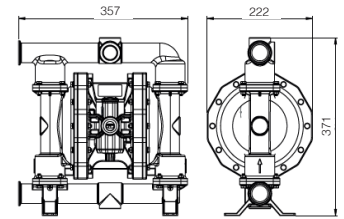

● Air supply pressure ● Air consumption Nlt/min [SCFM]  
The curves and performance values refer to pumps with submerged suction and free delivery outlet, with water at 20°C. These data may vary according to the construction materials and hydraulic conditions.

**Net Weight**

**Temperature**

17,2 kg

- 20 °C +95 °C

MODEL	CASING	DIAPHRAGM	BALLS	SEATS	GASKET	CONNECTIONS	ATEX	PORTS
PF0170	S = SS POLISHED	HT = HYTREL+PTFE	T = PTFE S = SS	S = SS	T = PTFE	3 = TRI-CLAMP 1 = BSP 6 = DIN	- = zone 2 X = zone 1	AB = STANDARD

# PF 400



SS ELECTRO-POLISHED



- Fluid connections **2" TRI-CLAMP  
DN 40 ISO 2852**
- Air connection **1/2" BSP**
- Max. Flow rate **380 lt/min**
- Max air pressure **8 bar**
- Max delivery head **80 m**
- Max Suction Lift Dry **5 m**
- Max Suction Lift Wet **9,8 m**
- Max Solid passing **8 mm**
- Noise level: **78 dB**
- Max Viscosity: **40.000 cps**
- Displacement per Stroke: **1200 CC ~**

- ⊕ II 3/3 G Ex h IIB T4 Gc
- ⊕ II 3 D Ex h IIIB T135°C Dc X

Displacement per stroke may vary based on suction condition, discharge head, air pressure and fluid type.

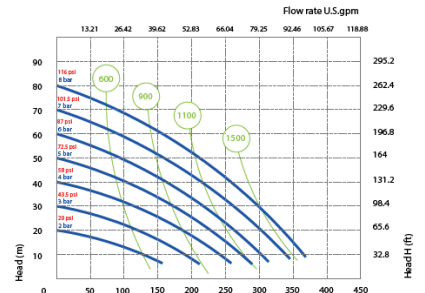
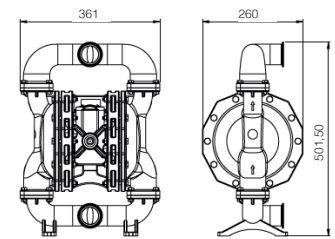

● Air supply pressure ● Air consumption Nlt/min [SCFM]  
The curves and performance values refer to pumps with submerged suction and free delivery outlet, with water at 20°C. These data may vary according to the construction materials and hydraulic conditions.

**Net Weight**

**Temperature**

25,3 kg

- 20 °C +95 °C

MODEL	CASING	DIAPHRAGM	BALLS	SEATS	GASKET	CONNECTIONS	ATEX	PORTS
PF0400	S = SS POLISHED	HT = HYTREL+PTFE	T = PTFE S = SS	S = SS	T = PTFE	3 = TRI-CLAMP 1 = BSP 6 = DIN	- = zone 2 X = zone 1	EF = STANDARD

# PF 700

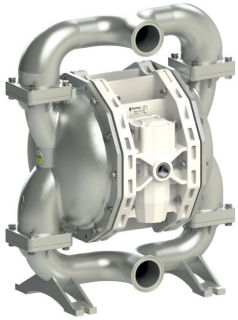

SS ELECTRO-POLISHED



Fluid connections	<b>2”1/2 TRI-CLAMP DN 50 ISO 2852</b>
Air connection	<b>3/4” BSP</b>
Max. Flow rate	<b>700 lt/min</b>
Max air pressure	<b>8 bar</b>
Max delivery head	<b>80 m</b>
Max Suction Lift Dry	<b>5 m</b>
Max Suction Lift Wet	<b>9,8 m</b>
Max Solid passing	<b>8,5 mm</b>
Noise level:	<b>78 dB</b>
Max Viscosity:	<b>50.000 cps</b>
Displacement per Stroke:	<b>3050 CC ~</b>

- Ⓧ II 3/3 G Ex h IIB T4 Gc
- Ⓧ II 3 D Ex h IIIB T135°C Dc X

Displacement per stroke may vary based on suction condition, discharge head, air pressure and fluid type.

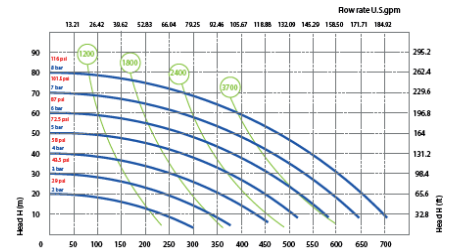
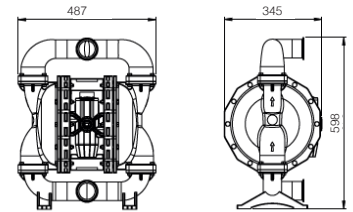

● Air supply pressure ● Air consumption Nit/min [SCFM]  
The curves and performance values refer to pumps with submerged suction and free delivery outlet, with water at 20°C. These data may vary according to the construction materials and hydraulic conditions.

Net Weight	Temperature
51 kg	- 20 °C +95 °C

# PF 1000



SS ELECTRO-POLISHED



Fluid connections	<b>3” TRI-CLAMP DN 80 ISO 2852</b>
Air connection	<b>3/4” BSP</b>
Max. Flow rate	<b>1050 lt/min</b>
Max air pressure	<b>8 bar</b>
Max delivery head	<b>80 m</b>
Max Suction Lift Dry	<b>5 m</b>
Max Suction Lift Wet	<b>9,8 m</b>
Max Solid passing	<b>12 mm</b>
Noise level:	<b>82 dB</b>
Max Viscosity:	<b>55.000 cps</b>
Displacement per Stroke:	<b>9750 CC ~</b>

- Ⓧ II 3/3 G Ex h IIB T4 Gc
- Ⓧ II 3 D Ex h IIIB T135°C Dc X

Displacement per stroke may vary based on suction condition, discharge head, air pressure and fluid type.

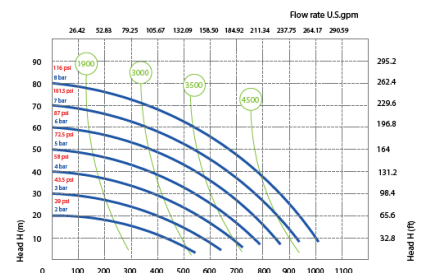
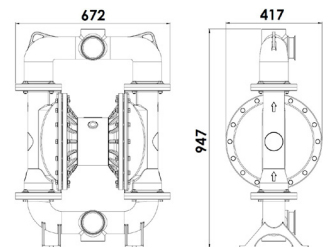

● Air supply pressure ● Air consumption Nit/min [SCFM]  
The curves and performance values refer to pumps with submerged suction and free delivery outlet, with water at 20°C. These data may vary according to the construction materials and hydraulic conditions.

Net Weight	Temperature
122 kg	- 20 °C +95 °C

MODEL	CASING	DIAPHRAGM	BALLS	SEATS	GASKET	CONNECTIONS	ATEX	PORTS
PF1000	S = SS POLISHED	HT = HYTREL+PTFE	T = PTFE S = SS	S = SS	T = PTFE	3 = TRI-CLAMP 1 = TRI-CLAMP 6 = DIN	- = zone 2 X = zone 1	AB = STANDARD



# SPECIAL PUMPS

PHOENIX ATEX - Ex ZONE I

PHOENIX ATEX - IECEx

ACCURATE PHOENIX

FLAP PHOENIX

STEEL PHOENIX

DRUM PHOENIX

SUBMERSIBLE PHOENIX

TWIN PHOENIX

POWDER PHOENIX

## PUMPS

ALL RANGE

## MAINS APPLICATIONS

- Petrol-Chemical industry
- Flexographic industry
- Food industry
- Painting industry
- Automotive industry

## ATEX MARKING

For the product design and conformity evaluation we used following documents:

- 2014/34/EU: ATEX Directive, on the approximation of European Member States laws concerning protection equipment and systems to be used in potentially explosive environments.
- UNI CEI EN ISO 80079-36:2016 - Explosive atmospheres - Part 36: Non-electrical equipment for explosive atmospheres - Basic method and requirements
- UNI CEI EN ISO 80079-37:2016 – Explosive atmospheres - Part 37: Non-electrical equipment for explosive atmospheres - non-electrical type of protection constructional safety “c”, control of ignition sources “b”, liquid immersion “k”.

To follow the ATEX marking referred to the equipment for explosive GAS atmosphere:

 **II 2/2 G Ex h IIC T4 Gb** (P01-P03-P07-P18-P30-P50-P55-P60-P65-P90-P100-P101- P120)

 **II 2/2 G Ex h IIB T4 Gb** (P160-P170-P171-P250-P252-P400-P700-P1000)

To follow the ATEX marking referred to the equipment for explosive DUST atmosphere:

 **II 2 D Ex h IIIB T 135°C Db X** (all models)



		Safety symbol	
<b>II</b>		Equipment group for surface	
<b>2/2 G</b>	Category 2 equipment that can be installed in the presence of an explosive atmosphere consisting of zone 1 gas, even indoors.	<b>2 D</b>	Category 2 equipment that can be installed in the presence of an explosive atmosphere consisting of zone 1 gas, even indoors.
<b>Ex</b>		Symbol to identify it as approved under the IECEx scheme	
<b>h</b>		Type of protection according to ISO IEC 80079-36:2016	
<b>IIB o IIC</b>	Product suitable for installation in the presence of Group IIB or IIC gas (depending on the model)	<b>IIIB</b>	Product suitable for installation in presence of Group IIIB dusts (excluding conductive dusts)
<b>T4</b>	Temperature class	<b>T135°C</b>	Maximum surface temperature
<b>Gb</b>	EPL Gb protection level in accordance with EN 60079-0: 12 and EN 80079-36: 16 Standards.	<b>Db</b>	EPL Gb protection level in accordance with EN 60079-0: 12 and EN 80079-36: 16 Standards.
<b>X</b>		Special Condition for safe use: the pump can't process explosive dust inside.	

Fluimac has filed with the BUREAU VERITAS certification body the documentation certifying ATEX compliance pursuant to Directive 2014/34 / UE for its ranges of AODD pumps and pulsation dampeners, with special construction materials to have zone 1 certification. The equipment user is responsible for classifying their installation zone. Before installation the equipment user always has to check the compliance with the classification of the installation zone.

## IECEX MARKING

For the product design and conformity evaluation we used following documents:

- UNI CEI EN ISO 80079-36:2016 - Explosive atmospheres - Part 36: Non-electrical equipment for explosive atmospheres - Basic method and requirements
- UNI CEI EN ISO 80079-37:2016 – Explosive atmospheres - Part 37: Non-electrical equipment for explosive atmospheres - non-electrical type of protection constructional safety “c”, control of ignition sources “b”, liquid immersion “k”.

To follow the IECEx marking referred to the equipment for explosive DUST atmosphere:

**Ex h IIC T4 Gb** (P01-P03-P07-P18-P30-P50-P55-P60-P65-P90-P100-P101- P120)

**Ex h IIB T4 Gb** (P160-P170-P171-P250-P252-P400-P700-P1000)

To follow the IECEx marking referred to the equipment for explosive DUST atmosphere:

**Ex h IIIB T 135°C Db** (all models)

<b>II</b>		Safety symbol	
<b>h</b>		Type of protection according to ISO IEC 80079-36:2016	
<b>IIB o IIC</b>	Product suitable for installation in the presence of Group IIB or IIC gas (depending on the model)	<b>IIIB</b>	Product suitable for installation in presence of Group IIIB dusts (excluding conductive dusts)
<b>T4</b>	Temperature class	<b>T135°C</b>	Maximum surface temperature
<b>Gb</b>	EPL Gb protection level in accordance with EN 60079-0: 12 and EN 80079-36: 16 Standards	<b>Db</b>	EPL Gb protection level in accordance with EN 60079-0: 12 and EN 80079-36: 16 Standards
<b>X</b>		Special Condition for safe use: the pump can't process explosive dust inside.	



Fluimac technical file is deposited with the certifying body IEC EUROFINS.

The equipment user is responsible for classifying their installation zone. Before installation the equipment user always has to check the compliance with the classification of the installation zone.

# PHOENIX ATEX FOR MINES

## PUMPS

ALL RANGE

I M2 Ex h I Mb X

## MAINS APPLICATIONS

- PETROL - CHIMICAL INDUSTRY
- FLEXOGRAPHIC INDUSTRY
- FOOD INDUSTRY
- PAINTING INDUSTRY
- AUTOMOTIVE INDUSTRY

I	Mines
M2	Category M2 equipment that can be installed in mines in "hazardous condition 2" that is in a potentially explosive atmosphere consisting of firedamp and coal dust.
Ex	Conventional symbol Ex
h	Protection mode for constructional safety "c"
I	Equipment for use in mine
Mb	Protection level EPL Mb in accordance with EN 60079-0:12 and EN 80079-36:16 standards.
X	The internal area of the pump is not ATEX, i.e., it cannot process explosive fluids when installed in mines. The pumps must be installed in areas with low impact risk.

NB: aluminium versions excluded



## TECHNICAL DATA

Fluimac technical file is deposited with the certifying body IEC EUROFINS. The equipment user is responsible for classifying their installation zone. Before installation the equipment user always has to check the compliance with the classification of the installation zone.

# ACCURATE PHOENIX

## PUMPS

AP7            AP90  
 AP18        AP120  
 AP30        AP170  
 AP60        AP252

## MAINS APPLICATIONS

- CHEMICAL INDUSTRY
- WASTE DISPOSAL TECHNOLOGY
- FLEXOGRAPHIC INDUSTRY
- PAINTING INDUSTRY
- PRINTING INDUSTRY
- WATER TREATMENT

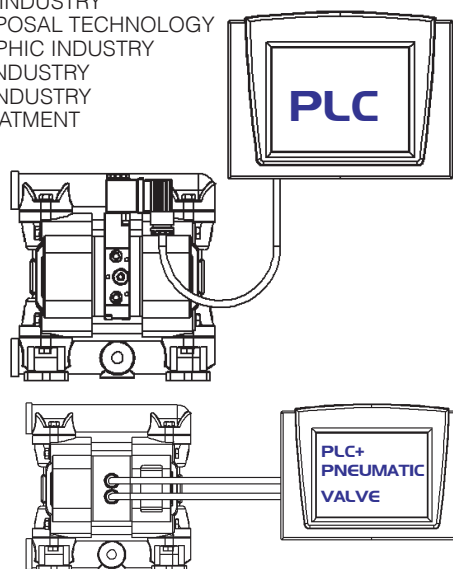

## TECHNICAL DATA

ACCURATE PHOENIX are Pumps that give you the external pump control necessary for exacting applications such as batching. Featuring a direct electrical interface that utilizes electrical impulses to stroke the pump instead of differential pressure, the ACCURATE PHOENIX provides a variable stroke rate that you can easily control as needed.

**Note: PLC and computer system not included.**



# FLAP PHOENIX

## PUMPS

FP0170	FPF0170
FP0400	FPF0400
FP0700	FPF0700
FP1000	FPF1000

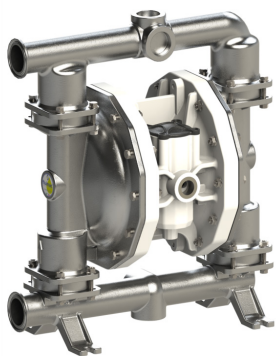

## MAIN APPLICATIONS

- WASTE DISPOSAL TECHNOLOGY
- FOOD INDUSTRY
- CERAMIC



## TECHNICAL DATA

FLAP PHOENIX are heavy duty flap valve pump has a proven design that solves the most common challenges in bad applications, sump applications, mine dewatering, food applications and any liquid application involving solids. Thanks to the FLAP valve the solid passing increase up to 30mm

# STEEL PHOENIX

## PUMPS

from SP0018 to SP0700 MODELS  
from SPF0018 to SPF0700 MODELS



## MAIN APPLICATIONS

- CHEMICAL INDUSTRY
- AUTOMOTIVE INDUSTRY
- FOOD INDUSTRY



## TECHNICAL DATA

The entire construction of the central block is made of Stainless Steel 316 making the PHOENIX STEEL air operated double diaphragms pumps series extremely resistant to corrosion, guaranteeing at the same time robust and solid solution for continuous operations, also with low or high temperature.

# DRUM PHOENIX

## PUMPS

DP18 - DP30 - DP60 - DP120 - DP170

### MAIN APPLICATIONS

- CHEMICAL INDUSTRY
- WASTE DISPOSAL TECHNOLOGY
- AUTOMOTIVE INDUSTRY
- FOOD INDUSTRY



### TECHNICAL DATA

**DRUM PHOENIX** are designed for emptying drums and containers, and provide an economical and wear resistant alternative to other pumping systems. In order to handle a wide range of fluids, DP pumps are available in all materials. The pump can be quickly and easily mounted on the drum with its feet. The drum will be completely emptied with a suction pipe.

# SUBMERSIBLE PHOENIX

## PUMPS

ALL RANGE

### MAIN APPLICATIONS

- CHEMICAL INDUSTRY
- WASTE DISPOSAL TECHNOLOGY
- FOOD INDUSTRY
- PETROL-CHEMICAL INDUSTRY PUMPS MAIN

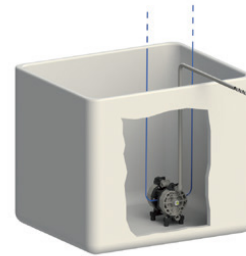

### TECHNICAL DATA

**SUBMERSIBLE** pumps may be submerged into the liquid. It is important to make sure that all components which are in contact with the liquid are chemically compatible. The air exhaust must be led to the atmosphere by means of a hose.

**NOTE: check the compatibility chart for all materials.**

# TWIN PHOENIX

## PUMPS

ALL RANGE

### MAIN APPLICATIONS

- PAINTING INDUSTRY
- WASTEWATER TECHNOLOGY
- PRINTING INDUSTRY
- PAPER PROCESSING
- FLEXOGRAPHIC INDUSTRY

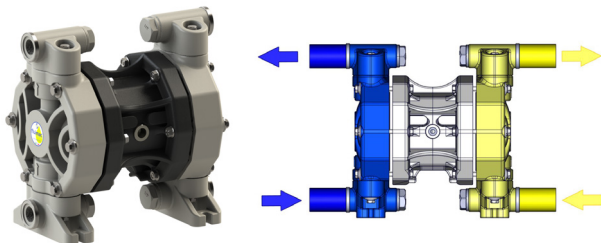

### TECHNICAL DATA

**TWIN PHOENIX** are mainly used in the textile and paper processing industry. These dual action pumps are able to transfer two different media independently and simultaneously. This is accomplished by using separate connections on the suction and discharge ports, keeping two pumped media isolated from each other, preventing unwanted mixing.

# POWDER PHOENIX

## PUMPS

ALL RANGE

### MAIN APPLICATIONS

- PAINTING INDUSTRY
- WASTEWATER TECHNOLOGY
- PRINTING INDUSTRY
- PAPER PROCESSING
- FLEXOGRAPHIC INDUSTRY



### TECHNICAL DATA

**POWDERS** pumps are designed to move bulk powders more effectively throughout your process vs. other unsafe and labor intensive means. These heavy duty pumps will consistently transfer fine-grained, low-bulk density dry powders in a dust-free operation.



# DAMPER

Pneumatic, automatic pulsation dampeners

**MATERIAL OF CONSTRUCTION:**

PP, PVDF, ALUMINIUM, SS AISI 316, POMc

Applicable to all size of pumps.

**ATEX ZONE 2 AND ZONE I CERTIFICATION**

Available also in FOOD version.

# DAMPER

The active pulsation dampener is the most efficient way to remove pressure variations on the discharge of the pump. Fluimac pulsation dampener works actively with compressed air and a diaphragm, setting automatically the correct pressure to minimize the pulsations. Pulsation dampeners require minimum maintenance and are, subject to the requirements of the application, available in the same housing and diaphragm materials as the pump.

## HOW IT WORK

The pulsating flow of the discharge forces the diaphragm upwards where it is cushioned by the air in the chamber. The flexing of the diaphragm absorbs the pulsation giving a smooth flow.

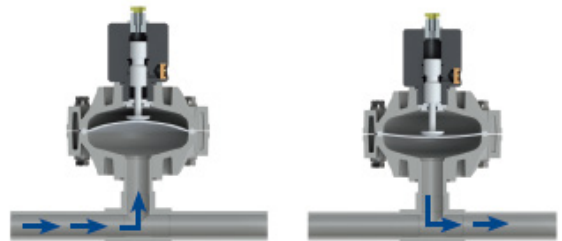

**Significant Pulsation Reduction with an average 70% - 80% pulsation reduction in high back pressure applications**

## APPLICATION

- METERING/ INJECTION/DOSING  
Equalizes discharge pressure spikes, increasing accuracy
- FILTER PRESS/INLINE FILTERS  
Increases filter efficiency and life by providing a smooth flow
- SPRAYING  
Smooth, consistent spray pattern.
- FILLING  
Eliminates inconsistent filling and splashing.
- TRANSFER  
Eliminates harmful water hammer, preventing pipe and valve damage.

## INSTALLATION



## PORT POSITION

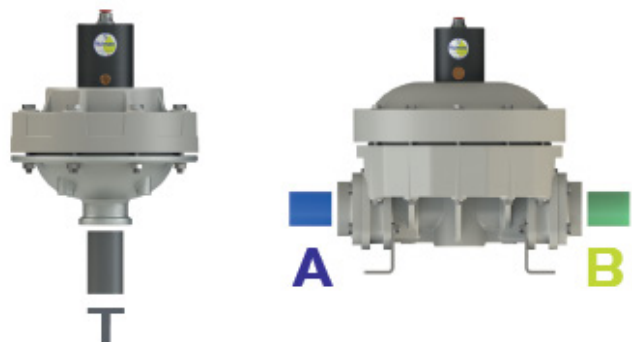

# D20



PP



PVDF+CF



POMc

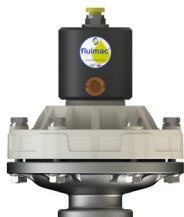

SS



SS  
(DF020)

Fluid connections **3/4" BSP**  
 Air connection **6 mm**  
 Max air pressure **8 bar**  
 Capacity Volume **80 CC ~**

⊕ II 3/3 G Ex h IIC T4 Gc  
 ⊕ II 3 D Ex h IIIB T135°C Dc X

**APPLY TO:  
4 - 8 - 20 - 35**

	PP	PVDF	POMc	SS
A (mm)	119	119	119	119
B (mm)	143	143	143	143
Net Weight Kg	0,65	0,7	0,65	2
Max Temperature	+65°C	+95°C	+80°C	+95°C
Min Temperature	-4°C	-20°C	-5°C	-20°C

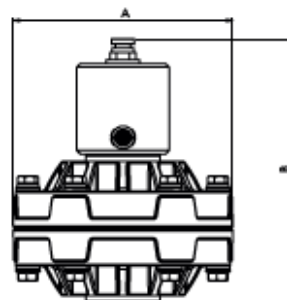

MODEL	CASING	DIAPHRAGM	CONNECTIONS	PORTS
D020	P = PP KC = PVDF+CF O = POMc S = SS	HT = HYTREL+PTFE MT = SANTOPRENE+PTFE H = HYTREL W = SANTOPRENE H.R.	1 = BSP 2 = FLANGE 5 = NPT	T = STANDARD
DF020	S = SS	HT = HYTREL+PTFE	3 = TRI-CLAMP	T = STANDARD

# D25



PP



PVDF+CF



POMc



SS



SS  
(DF025)

Fluid connections **1" BSP**  
 Air connection **8 mm**  
 Max air pressure **8 bar**  
 Capacity Volume **200 CC ~**

⊕ II 3/3 G Ex h IIC T4 Gc  
 ⊕ II 3 D Ex h IIIB T135°C Dc X

**APPLY TO:  
55 - 60 - 90 - 120**

	PP	PVDF	POMc	SS
A (mm)	181	181	181	181
B (mm)	195	195	195	195
Net Weight Kg	1,75	2	1,9	6,7
Max Temperature	+65°C	+95°C	+80°C	+95°C
Min Temperature	-4°C	-20°C	-5°C	-20°C

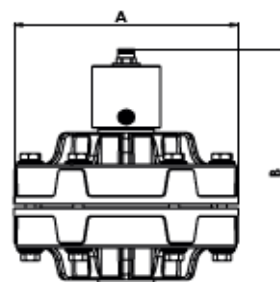

MODEL	CASING	DIAPHRAGM	CONNECTIONS	PORTS
D025	P = PP KC = PVDF+CF O = POMc S = SS	HT = HYTREL+PTFE MT = SANTOPRENE+PTFE H = HYTREL W = SANTOPRENE H.R. D = EPDM N = NBR	1 = BSP 2 = FLANGE 3 = TRI-CLAMP 5 = NPT	T = STANDARD
DF025	S = SS	HT = HYTREL+PTFE	3 = TRI-CLAMP	T = STANDARD

# D40

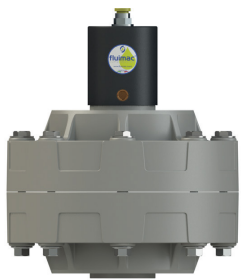

PP

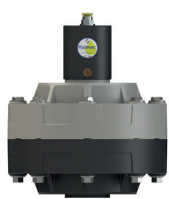

PVDF+CF



POMc



SS



SS  
(DF040)

Fluid connections **1" 1/2 BSP**  
 Air connection **10 mm**  
 Max air pressure **8 bar**  
 Capacity Volume **700 CC ~**

⊕ II 3/3 G Ex h IIB T4 Gc  
 ⊕ II 3 D Ex h IIIB T135°C Dc X

**APPLY TO:  
170 - 252 - 400**

	PP	PVDF	POMc	SS
<b>A (mm)</b>	231	231	231	231
<b>B (mm)</b>	270	270	270	267
<b>Net Weight Kg</b>	4	4,6	4,2	5,6
<b>Max Temperature</b>	+65°C	+95°C	+80°C	+95°C
<b>Min Temperature</b>	-4°C	-20°C	-5°C	-20°C

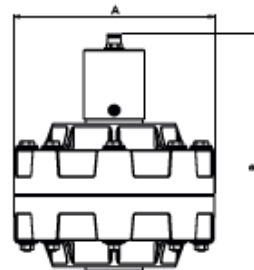

MODEL	CASING	DIAPHRAGM	CONNECTIONS	PORTS
D040	P = PP KC = PVDF+CF O = POMc S = SS	HT = HYTREL+PTFE MT = SANTOPRENE+PTFE H = HYTREL W = SANTOPRENE H.R. D = EPDM N = NBR	1 = BSP 2 = FLANGE 5 = NPT	T = STANDARD
DF040	S = SS	HT = HYTREL+PTFE	3 = TRI-CLAMP	T = STANDARD

# D50



PP



PVDF+CF



ALU



SS



SS  
(DF050)

Fluid connections **2" BSP**  
 Air connection **12 mm**  
 Max air pressure **8 bar**  
 Capacity Volume **2900 CC ~**

⊕ II 3/3 G Ex h IIB T4 Gc  
 ⊕ II 3 D Ex h IIIB T135°C Dc X

**APPLY TO:  
700 - 1000**

	PP	PVDF	POMc	SS
<b>A (mm)</b>	404	404	400	402
<b>B (mm)</b>	425	425	425	408
<b>Net Weight Kg</b>	14	17	14,5	21,6
<b>Max Temperature</b>	+65°C	+95°C	+80°C	+95°C
<b>Min Temperature</b>	-4°C	-20°C	-5°C	-20°C

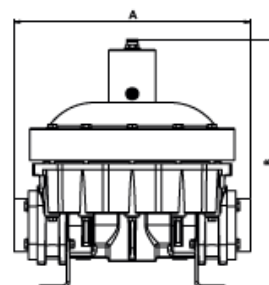

MODEL	CASING	DIAPHRAGM	O-RING	CONNECTIONS	PORTS
D050	P = PP KC = PVDF+CF A = ALU S = SS	HT = HYTREL+PTFE MT = SANTOPRENE+PTFE H = HYTREL W = SANTOPRENE H.R. D = EPDM N = NBR	D = EPDM V = VITON N = NBR T = PTFE	1 = BSP 2 = FLANGE 5 = NPT	AB = STANDARD
DF050	S = SS	HT = HYTREL+PTFE	T = PTFE	3 = TRI-CLAMP	AB = STANDARD



# LOTUS

**MATERIALS OF COSTRUCTION:**  
PTFE, PTFE+CF, PE, PE+CF, PP  
Flow-rate from 10 lt/min to 110 lt/min  
ATEX VERSION AVAILABLE

# L

# 0015

# T-

# DT

# T

MODEL

SIZE

CASING

DIAPHRAGM

BALL

**L**  
LOTUS



**10**  
10 lt/min  
3/8" BSPP

**15**  
55 lt/min  
1/2" BSPP

**25**  
110 lt/min  
1 BSPP



**T**  
**PTFE**  
Widest chemical compatibility, extreme corrosion resistance, non-adhesive, high heat resistance.



**TC**  
**CONDUCTIVE PTFE**  
Widest chemical compatibility, extreme corrosion resistance, non-adhesive, high heat resistance. Groundable.



**Z**  
**PE**  
With high molecular weight: High level of abrasion resistance.



**ZC**  
**CONDUCTIVE PE**  
With high molecular weight: High level of abrasion resistance. Groundable.



**PP**  
**PURE POLYPROPYLENE**  
Wide chemical compatibility. General purpose.



**DT**  
**EPDM+PTFE**  
Widest chemical compatibility, extreme corrosion resistance, non-adhesive, high heat resistance.



**D**  
**EPDM**  
OK with caustic solutions, dilute acids, ketones and alcohols. Good abrasion resistance.



**T**  
**PTFE**  
Widest chemical compatibility, extreme corrosion resistance, non-adhesive, high heat resistance.

**S**  
**SS**  
High level of corrosion and abrasion resistance. Good for viscous fluids.



**D**  
**EPDM**  
OK with caustic solutions, dilute acids, ketones and alcohols. Good abrasion resistance.



## PUMP OPERATION

○ Fluid  
○ Air

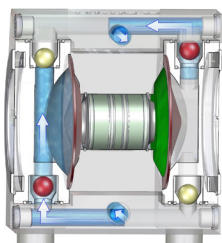

### Suction Cycle

Compressed air fills right inner chamber, causing the opposing diaphragm to create suction, lifting the lower valve ball, pulling in fluid at inlet. Simultaneously, the right chamber is in "Discharge" cycle.

1

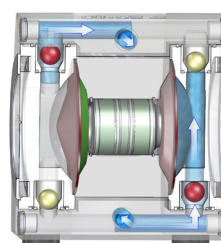

### Discharge Cycle

Compressed air fills left inner chamber, causing upper valve ball to open and discharge fluid. Simultaneously, the right chamber is in "Suction" cycle.

2



# T

# T

# 1

# -

# EF

## BALL SEAT

**T**  
**PTFE**

Widest chemical compatibility, extreme corrosion resistance, non-adhesive, high heat resistance

**Z**  
**PE**

With high molecular weight: High level of abrasion resistance.

**PP**  
**PURE POLYPROPYLENE**

Wide chemical compatibility. General purpose.

## GASKET

**T**  
**PTFE**

Widest chemical compatibility, extreme corrosion resistance, non-adhesive, high heat resistance.

**F**  
**FEP-FKM**

With high molecular weight: High level of abrasion resistance.

**D**  
**EPDM**

Good with caustic solutions, dilute acids, ketones and alcohols. Good abrasion resistance.

## CONNECTIONS

**1**

BSP THREADED

**2**

FLANGED

**5**

NPT THREADED

## ATEX ZONE CERTIFICATION



### ATEX ZONE 2

L10 and L15 models

II 3/3 G Ex h IIC T4 Gc

II 3 D Ex h IIIB T135°C Dc X

L25 model

II 3/3 G Ex h IIB T4 Gc

II 3 D Ex h IIIB T135°C Dc X

### X ATEX ZONE 1

L10 and L15 models

II 2/2 G Ex h IIC T4 Gb

II 2 D Ex h IIIB T135°C Db X

L25 model

II 2/2 G Ex h IIB T4 Gb

II 2 D Ex h IIIB T135°C Db X

## PORTS

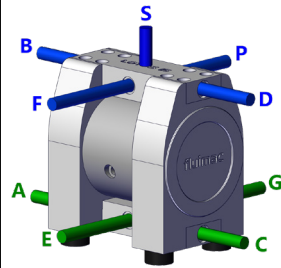

**TABLE CODE**

## SPECIAL FEATURES

**TL PTFE LOTUS** CENTRAL BLOCK IN PTFE

## INSTALLATION



**Pump installed below head (positive suction)**  
when it is necessary to empty completely the container



**Pump installed above drum or tank**  
with special featuring pump



**Pump installed on a mobile unit**  
with a trolley or cart when pump must be often moved



**Self priming pump installed above head (negative suction)**  
pump initially works with dry column without problem



**Chemical System**  
pumps are suitable to be integrated in dosing systems for concentrated acids at high temperature

# TECHNICAL FEATURES

The materials of construction of the Lotus series are PTFE, CONDUCTIVE PTFE, PE, CONDUCTIVE PE and PURE POLYPROPYLENE. The Lotus pumps are suitable to work with hazardous chemicals such as acids, caustics, and solvents.

## FEATURES AND BENEFITS

- Machined plastic design
- Increased capacity
- Increased safety
- Decreased air consumption
- Easy cleanability
- Reduced noise level
- Decreased downtime
- Optimized flow pattern
- Increased quality
- Long service life
- Increased reliability
- Used in demanding process applications
- Robust plastic design with reinforcement ring for enhanced sealing and torque retention



## APPLICATIONS

- Abrasive Slurries
- Solar Cell
- Biopharmaceutical
- Chemicals
- Etching Agents
- Ceramic
- Sludge Transfer
- Glazes Transfer
- Paints
- Varnish
- High Concentrated Acids and Bases
- Grinding and Drilling Emulsions
- Paper and Printing
- Glue Transport
- Printing Inks Transport
- Industrial Water Treatment
- Sample Analysis
- Wastewater Neutralization
- Feeding Filter Presses with Sludge
- Chemical Treatment of Wafers
- Corrosive, Hazardous or Toxic Chemicals

### Machined for Precision

FLUIMAC's solid plastic block increases the pump's strength and life cycle while eliminating many maintenance concerns. The LOTUS Series CNC machined solid block of PTFE, PE or PP allows to deal with the harshest environments. The LOTUS Series solid plastic block construction is mechanically machined rather than injection moulded. The CNC technology enables tight tolerances, along with reduced vibration, less risk of leakage, and greater stability and durability. The high static mass leads to smooth operation with reduced vibration.



## TECHNICAL DATA

Fluid connections	<b>3/8" BSP</b>
Air connection	<b>1/4" BSP</b>
Max. Flow rate	<b>24 lt/min</b>
Max air pressure	<b>7 bar</b>
Max delivery head	<b>70 m</b>
Max Suction Lift Dry	<b>4 m</b>
Max Suction Lift Wet	<b>9,8 m</b>
Max Solid passing	<b>3 mm</b>
Noise level:	<b>65 dB</b>
Max Viscosity:	<b>15.000 cps</b>
Displacement per Stroke:	<b>65 CC ~</b>

II 3/3 G Ex h IIB T4 Gb  
 II 3 D Ex h IIB T135°C Db X

Displacement per stroke may vary based on suction condition, discharge head, air pressure and fluid type.

## PERFORMANCE

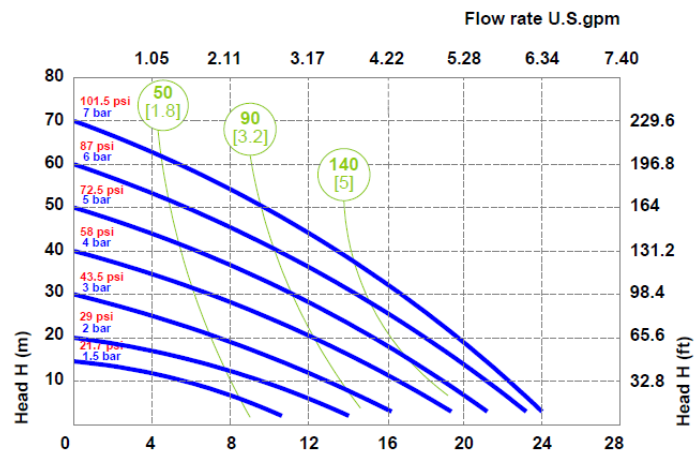

Air supply pressure  
 Air consumption Nit/min [SCFM]

The curves and performance values refer to pumps with submerged suction and a free delivery outlet with water at 20°C. These data may vary according to the construction materials and hydraulic conditions.

## DIMENSIONS

	A	B	C	Net Weight	Temperature
<b>PTFE</b>	157 mm	110 mm	180 mm	5 kg	- 20 °C   + 120 °C
<b>PTFE+CF</b>	157 mm	110 mm	180 mm	5 kg	- 20 °C   + 120 °C
<b>PE</b>	157 mm	110 mm	180 mm	2,5 kg	- 4 °C   + 65 °C
<b>PE+CF</b>	157 mm	110 mm	180 mm	2,5 kg	- 4 °C   + 65 °C
<b>PP</b>	157 mm	110 mm	180 mm	2,5 kg	- 4 °C   + 65 °C

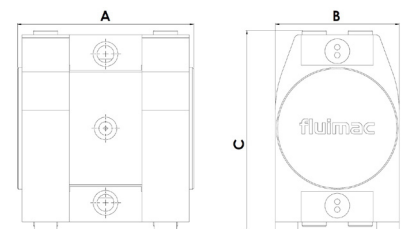

## COMPOSITION

MODEL	CASING	DIAPHRAGM	BALLS	SEATS	GASKET	CONNECTIONS	ATEX	PORTS
<b>L010</b>	T = PTFE TC = PTFE+CF Z = PE ZC = PE+CF PP = PURE PP	DT = EPDM+PTFE D = EPDM	T = PTFE S = SS D = EPDM	T = PTFE Z = PE PP = PURE PP	T = PTFE F = FEP+FKM D = EPDM	1 = BSP 2 = FLANGED 5 = NPT	- = zone 2 X = zone 2	EF = STANDARD



## TECHNICAL DATA

Fluid connections	<b>1/2" BSP</b>
Air connection	<b>1/4" BSP</b>
Max. Flow rate	<b>55 lt/min</b>
Max air pressure	<b>8 bar</b>
Max delivery head	<b>80 m</b>
Max Suction Lift Dry	<b>4 m</b>
Max Suction Lift Wet	<b>9,8 m</b>
Max Solid passing	<b>3,5 mm</b>
Noise level:	<b>70 dB</b>
Max Viscosity:	<b>20.000 cps</b>
Displacement per Stroke:	<b>140 CC ~</b>

II 3/3 G Ex h IIB T4 Gb  
 II 3 D Ex h IIB T135°C Db X

Displacement per stroke may vary based on suction condition, discharge head, air pressure and fluid type.

## PERFORMANCE

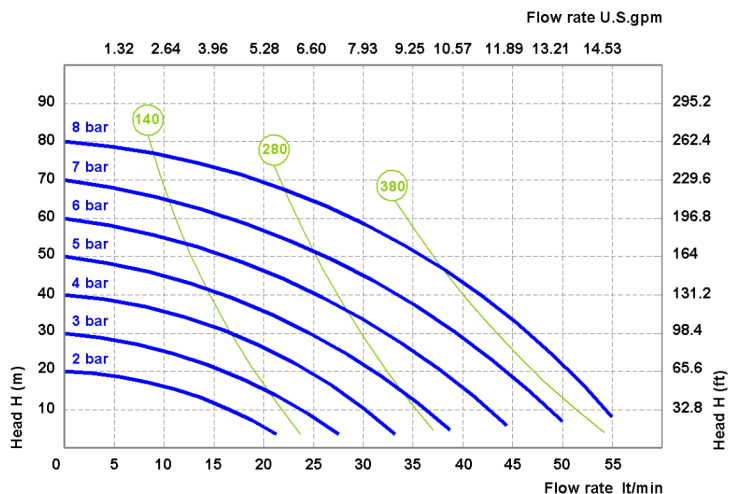

The curves and performance values refer to pumps with submerged suction and a free delivery outlet with water at 20°C. These data may vary according to the construction materials and hydraulic conditions.

## DIMENSIONS

	A	B	C	Net Weight	Temperature	
<b>PTFE</b>	226 mm	160 mm	260 mm	14 kg	- 20 °C	+ 95 °C
<b>PTFE+CF</b>	226 mm	160 mm	260 mm	14 kg	- 20 °C	+ 95 °C
<b>PE</b>	226 mm	160 mm	260 mm	6,7 kg	- 4 °C	+ 65 °C
<b>PE+CF</b>	226 mm	160 mm	260 mm	6,7 kg	- 4 °C	+ 65 °C
<b>PP</b>	226 mm	160 mm	260 mm	6,7 kg	- 4 °C	+ 65 °C

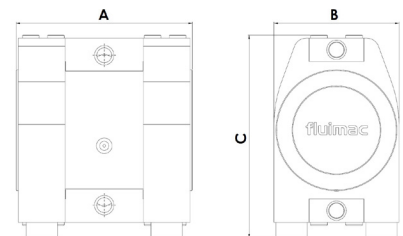

## COMPOSITION

MODEL	CASING	DIAPHRAGM	BALLS	SEATS	GASKET	CONNECTIONS	ATEX	PORTS
<b>L015</b>	T = PTFE TC = PTFE+CF Z = PE ZC = PE+CF PP = PURE PP	DT = EPDM+PTFE D = EPDM	T = PTFE S = SS D = EPDM	T = PTFE Z = PE PP = PURE PP	T = PTFE F = FEP+FKM D = EPDM	1 = BSP 2 = FLANGED 5 = NPT	- = zone 2 X = zone 2	EF = STANDARD



## TECHNICAL DATA

Fluid connections	<b>1" BSP</b>
Air connection	<b>1/2" BSP</b>
Max. Flow rate	<b>110 lt/min</b>
Max air pressure	<b>8 bar</b>
Max delivery head	<b>80 m</b>
Max Suction Lift Dry	<b>5 m</b>
Max Suction Lift Wet	<b>9,8 m</b>
Max Solid passing	<b>4 mm</b>
Noise level:	<b>72 dB</b>
Max Viscosity:	<b>25.000 cps</b>
Displacement per Stroke:	<b>200 CC ~</b>

II 3/3 G Ex h IIB T4 Gb  
 II 3 D Ex h IIB T135°C Db X

Displacement per stroke may vary based on suction condition, discharge head, air pressure and fluid type.

## PERFORMANCE

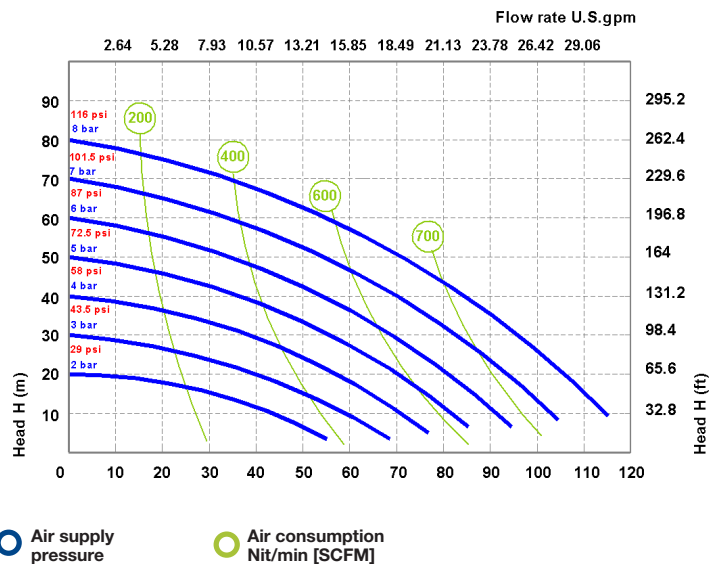

Air supply pressure  
 Air consumption Nit/min [SCFM]

The curves and performance values refer to pumps with submerged suction and a free delivery outlet with water at 20°C. These data may vary according to the construction materials and hydraulic conditions.

## DIMENSIONS

	A	B	C	Net Weight	Temperature
<b>PTFE</b>	275 mm	210 mm	334 mm	28,3 kg	- 20 °C   + 95 °C
<b>PTFE+CF</b>	275 mm	210 mm	334 mm	28,3 kg	- 20 °C   + 95 °C
<b>PE</b>	275 mm	210 mm	334 mm	28,3 kg	- 20 °C   + 95 °C
<b>PE+CF</b>	275 mm	210 mm	334 mm	13,83	- 4 °C   + 65 °C
<b>PP</b>	275 mm	210 mm	334 mm	13,83	- 4 °C   + 65 °C

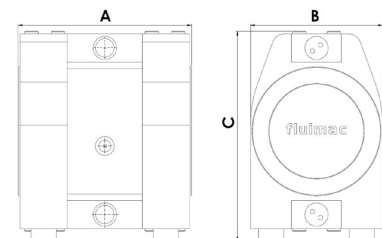

## COMPOSITION

MODEL	CASING	DIAPHRAGM	BALLS	SEATS	GASKET	CONNECTIONS	ATEX	PORTS
<b>L025</b>	<b>TF</b> = PTFE <b>TF</b> = PTFE+CF <b>Z</b> = PE <b>ZC</b> = PE+CF <b>PP</b> = PURE PP	<b>DT</b> = EPDM+PTFE <b>D</b> = EPDM	<b>T</b> = PTFE <b>S</b> = SS <b>D</b> = EPDM	<b>T</b> = PTFE <b>Z</b> = PE <b>PP</b> = PURE PP	<b>T</b> = PTFE <b>F</b> = FEP+FKM <b>D</b> = EPDM	<b>1</b> = BSP <b>2</b> = FLANGED <b>5</b> = NPT	<b>-</b> = zone 2 <b>X</b> = zone 1	<b>EF</b> = STANDARD



# PIEZO

**MATERIALS OF CONSTRUCTION:**  
PP, PVDF, POMc, POMc+CF  
Flow-rate 8 lt/min  
ATEX VERSION AVAILABLE

# PIEZO

FLUIMAC developed and patented a new pump model, PIEZO PUMP, a unique pump, designed for the environmental remediation applications.

PIEZO PUMP is an easily transportable pneumatic system, which can be installed inside wells with a minimum internal diameter of 4" for the following purposes:

- Groundwater pumping as part of remediation activities or remediation plants;
- Recovery Technology for LNAPL / DNALP (light / dense non-aqueous phase liquid);
- Oil handling in ATEX classified areas;
- Low-flow representative sampling at different depths inside environmental monitoring wells;
- Excellent tool for environmental emergency response activities.

## FEATURES:

- Operation with high subsidence value of water level (max. approx. 50 m);
- Possibility to work both above and below the water level;
- Can work with solids in the water flow (max. approx. 2.5 mm);
- Constant pumping at low flow rates (approx. 0.25-4.00 l/min)
- Easy flow management through compressed air supply;
- Lightweight, compact and compatible with 4" wells;
- Possibility to send the air exhaust out of the well.



## INSTALLATION

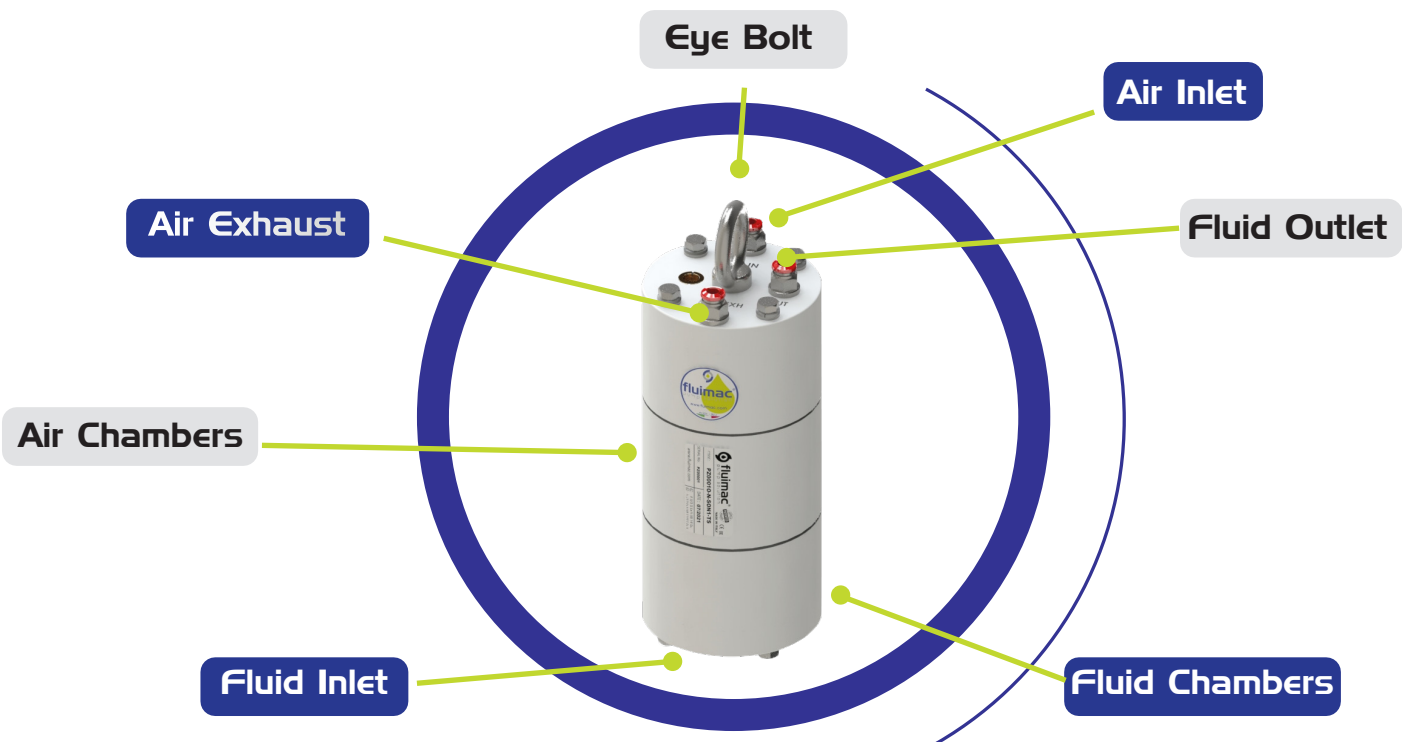
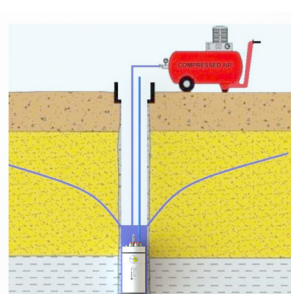
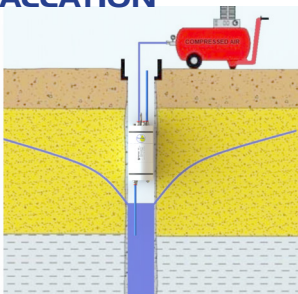

# PZ 0001

# P-

# TT

# S

MODEL

SIZE

CASING

DIAPHRAGM

BALL

**PZ**  
PIEZO PUMP



**1**

8 lt/min  
1/4" BSPP



**P**  
**POLYPROPYLENE**

Wide chemical compatibility. General purpose. Reinforced with glass-fiber.



**K**  
**PVDF**

Strong chemical resistance to acids. High temperature resistance. Groundable.



**O**  
**ACETAL**

Wide range of solvent and hydrocarbons resistance. Good level of abrasion resistance.



**OC**  
**CONDUCTIVE ACETAL**

Wide range of solvent and hydrocarbons. Good level of abrasion resistance. Groundable.



**N**  
**NBR**

Good for petroleum-based fluids, water, oils, hydrocarbons and MILD chemicals.



**T**  
**PTFE**

Widest chemical compatibility, extreme corrosion resistance, non-adhesive, high heat resistance.



**T**  
**PTFE**

Widest chemical compatibility, extreme corrosion resistance, non-adhesive, high heat resistance.



**S**  
**SS**

High level of corrosion and abrasion resistance. Good for viscous fluids.



# O

# V

# 1

# -

# TS

## BALL SEAT

## GASKET

## CONNECTIONS

## ATEX ZONE CERTIFICATION

## PORTS



**P**  
**POLYPROPYLENE**  
Wide chemical compatibility.  
General purpose.



**K**  
**PVDF**  
Strong chemical resistance to acids.  
High temperature resistance.



**O**  
**ACETAL**  
Wide range of solvent and hydrocarbons resistance. Good level of abrasion resistance.



**V**  
**VITON**  
High heat resistance.  
Good resistance to aggressive chemicals and hydrocarbons.



**N**  
**NBR**  
Good for petroleum-based fluids, water, oils, hydrocarbons and MILD chemicals.

**1**  
BSP THREADED



**-**  
ATEX ZONE 2  
II 3/3 G Ex h IIC T4 Gc  
II 3 D Ex h IIIB T135°C Dc X

**X**  
ATEX ZONE 1  
II 2/2 G Ex h IIC T4 Gb  
II 2 D Ex h IIIB T135°C Db X



# TABLE CODE

# PIEZO PUMP I



## TECHNICAL DATA

Fluid connections	<b>1/4" BSP</b>
Air connection	<b>1/4" BSP</b>
Max. Flow rate	<b>8 lt/min</b>
Max air pressure	<b>6 bar</b>
Max delivery head	<b>60 m</b>
Max Suction Lift Dry	<b>3 m</b>
Max Solid passing	<b>2 mm</b>
Noise level	<b>65 dB</b>
Max Viscosity	<b>5.000 cps</b>
Displacement per Stroke	<b>24 CC ~</b>

II 3/3 G Ex h IIB T4 Gc  
II -/3 D Ex h IIB T135°C Dc X

Displacement per stroke may vary based on suction condition, discharge head, air pressure and fluid type.

## PERFORMANCE

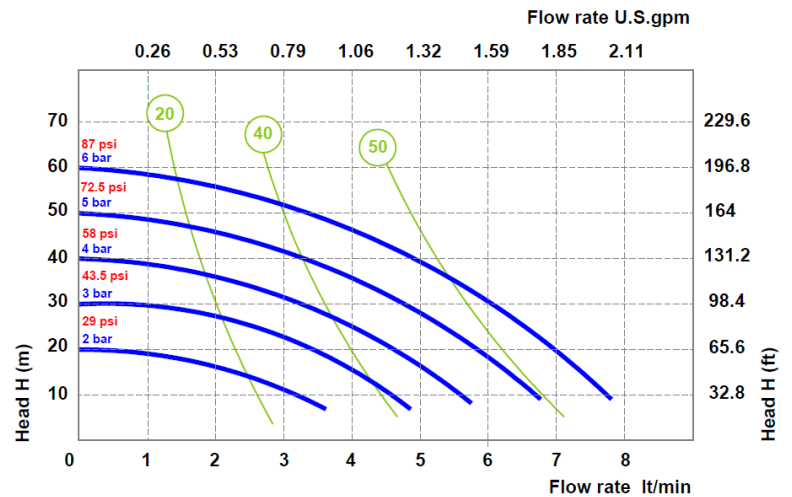

○ Air supply pressure      ○ Air consumption Nl/min [SCFM]

The curves and performance values refer to pumps with submerged suction and a free delivery outlet with water at 20°C. These data may vary according to the construction materials and hydraulic conditions.

## DIMENSIONS

	A	B	Net Weight	Temperature	
<b>POMC+CF</b>	90 mm	242 mm	1,7 kg	- 5 °C	+ 80 °C
<b>POMc</b>	90 mm	242 mm	1,7 kg	- 5 °C	+ 80 °C
<b>PVDF</b>	90 mm	242 mm	2,2 kg	- 20 °C	+ 69 °C
<b>PP</b>	90 mm	242 mm	1,7 kg	- 4 °C	+ 65 °C

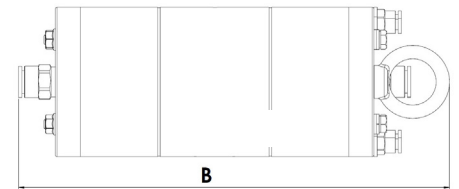
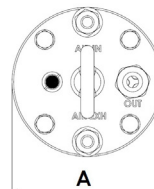

## COMPOSITION

MODEL	CASING	DIAPHRAGM	BALLS	SEATS	GASKET	CONNECTIONS	ATEX	PORTS
<b>PZ001</b>	O = POMc P = PP K = PVDF OC = POM+CF	N = NBR TT = PTFE+PTFE	T = PTFE S = SS	O = POMc P = PP K = PVDF	N = NBR V = VITON D = EDPM	1 = BSP	- = ZONE 2 X = ZONE 1	TS = STANDARD

# ACCESSORIES



## AIR REGULATION KIT

Adjust and set air pressure and air flow-rate with a filter regulator, pressure gauge and air valve unit.



## INOX TROLLEY

It makes pumps transportable.



## SWITCH VALVES

Remotely start and stop with a solenoid or pneumatic valve for the pump's air line.



## ANTI VIBRATION FEET KIT

Reduces physical vibration from AODD pump operation.



## STROKE COUNTER

Count the number of strokes, connected to a control. It allows various type of monitoring.



## PP, PVDF, ALU SS NOZZLE

Dispenser to delivery control and batching.



## DIAPHRAM FAILURE DETECTION FLUID-GUARD

The Leak Detector provide a signal and the pump can be shut down when diaphragms fail.



## REINFORCED PVC HOSE

With metal reinforcement for suction/discharge, also food-grade.



## PNEUMATIC BATCH CONTROL

Pneumatic batcher can control any FLUIMAC AODD pump allowing you to set the cycles amount and count the strokes



## FOOT BALL VALVE

Realized in PP and PVDF.  
Size available 1" - 1"1/4 - 1"1/2 - 2"  
Used to prevent the suction hose from emptyng.



## ELECTRONIC BATCH CONTROL

Electronic batcher can control any FLUIMAC AODD pump allowing you to set the cycles amount and count the strokes



## VALVES FITTINGS AND CONNECTIONS IN PP, PVC, INOX



## BASKET STRAINER FILTERS IN PP

Installed on the suction of the pumps, protects them from suspended solids and impurity.



## FLANGE CONNECTION KIT

It modifies a pump with BSP connection into a flanged pump.



## PRESSURE BOOSTER

Where the line pressure is not enough, this system doubles the in let pressure to supply correctly the air to the pump



## WALL FIXING BRACKET

Wall fixing bracket for diaphragm pumps, for all sizes.

# fluimac<sup>®</sup>

pump solution

Made in  
Italy



Environmental Technology AS  
Fabrikkveien 6  
4323 Sandnes, Norway

ENVITEC  
[www.envitec.no](http://www.envitec.no)  
[post@envitec.no](mailto:post@envitec.no)

## ENVITEC<sup>®</sup>

